

ORDINANCE NO. _____

AN ORDINANCE BY THE CITY COUNCIL OF THE CITY OF FORT WORTH, APPROVING RESOLUTION NOS. 2022-06-121 AND 2022-08-174, ADOPTED BY THE DALLAS FORT WORTH INTERNATIONAL AIRPORT BOARD ON JUNE 2, 2022 AND AUGUST 4, 2022, RESPECTIVELY, FOR THE PURPOSE OF AMENDING THE CONSTRUCTION AND FIRE PREVENTION STANDARDS AND CHAPTERS 2 AND 8 OF THE CODE OF RULES AND REGULATIONS OF THE DALLAS FORT WORTH INTERNATIONAL AIRPORT BOARD.

WHEREAS, Section 8.F. of the 1968 Contract and Agreement, as amended, between the City of Dallas, Texas and the City of Fort Worth, Texas, provides that the Dallas Fort Worth International Airport Board shall have the power, by a duly adopted order, to adopt and enforce rules and regulations for the orderly, safe, efficient, and sanitary operation of the airport and to prescribe reasonable penalties for the breach of any rule or regulation not to exceed the maximum fines authorized by state law; and

WHEREAS, state law currently authorizes fines of up to \$500 for all violations of the airport's rules and regulations, except for those violations relating to fire safety, public health and sanitation, or the dumping of refuse, for which the maximum fine is \$2,000, and except when another fine is fixed by state law; and

WHEREAS, Sections 22.082 of the Texas Transportation Code, as amended, and Section 8.F. of the 1968 Contract and Agreement, as amended, provide that such rules, regulations or orders by the Dallas Fort Worth International Airport Board will become effective only upon approval of the governing bodies of the Cities of Dallas and Fort Worth and proper publication; and

WHEREAS, pursuant to the foregoing, the Dallas Fort Worth International Airport Board adopted the Code of Rules and Regulations, which regulates traffic, travel, and conduct within the Dallas-Fort Worth International Airport ("Airport") and establishes certain procedures for the adoption of additional rules, regulations and orders; and

WHEREAS, on June 2, 2022 and August 4, 2022, respectively, the Dallas-Fort Worth International Airport Board passed, approved, and ordered (i) Resolution No. 2022-06-121 which would amend the Construction and Fire Prevention Standards at the Airport; and (ii) and Resolution No. 2022-08-174 which would amend Chapter 2 (Traffic Regulation) and Chapter 8 (Commercial Activities) of the Code of Rules and Regulations of the Dallas Fort Worth International Airport Board; and

WHEREAS, in accordance with Section 1-8 of Chapter 1 of the Code of Rules and Regulations of the Dallas-Fort Worth International Airport Board, as amended, the Dallas-Fort Worth International Airport Board has requested that the City Councils of the Cities of Dallas and Fort Worth approve Resolution Nos. 2022-06-121 and 2022-08-174 in order that it may become effective.

**NOW, THEREFORE, BE IT ORDAINED BY THE CITY COUNCIL OF THE
CITY OF FORT WORTH TEXAS:**

SECTION 1.

That all of the declarations and findings contained in the preambles of this ordinance are made a part hereof and shall be fully effective as a part of the ordained subject matter of this ordinance.

SECTION 2.

That Resolution Nos. 2022-06-121 and 2022-08-174 of the Dallas Fort Worth International Airport Board, duly certified copies of which are attached hereto as Exhibit “A” and Exhibit “B”, respectively, made a part of this ordinance by reference, are hereby approved.

SECTION 3.

That after publication of a substantive statement relating to the contents of Resolution Nos. 2022-06-121 and 2022-08-174 of the Dallas Fort Worth International Airport Board in a newspaper of general circulation in each of the counties of Dallas and Tarrant, stating that a breach of any provision of Resolution No. 2022-06-121 and 2022-08-174 will subject the violator to a penalty and stating that the full text of Resolution Nos. 2022-06-121 and 2022-08-174 and any attachments are on file in the principal office of the Dallas Fort Worth International Airport Board to be read by any interested party, Resolution Nos. 2022-06-121 and 2022-08-174 shall thereafter have the same force and effect within the boundaries of the Dallas-Fort Worth

International Airport as an ordinance by the City Council of the City of Fort Worth would have in the City of Fort Worth, and the penalty shall be enforced in the same manner in which penalties prescribed by other ordinances of the City of Fort Worth are enforced.

SECTION 4.

That the sections, paragraphs, sentences, clauses, and phrases of this ordinance and Resolution Nos. 2022-06-121 and 2022-08-174 are severable, and if any phrase, clause, sentence, paragraph, or section shall be declared unconstitutional or invalid by the valid judgment or decree of any court of competent jurisdiction, the unconstitutionality or invalidity shall not affect any of the remaining phrases, clauses, sentences, paragraphs, and sections of these ordinances or Resolution Nos. 2022-06-121 and 2022-08-174, since the same would have been enacted without the incorporation of any unconstitutional phrase, clause, sentence, paragraph, or section.

SECTION 5.

That this ordinance will take effect immediately from and after its passage and publication in accordance with the provisions of the Charter of the City of Fort Worth, and it is accordingly so ordained.

APPROVED AS TO FORM AND LEGALITY:

By: _____
Leann Guzman, City Attorney

Adopted and Effective: _____

September 13, 2022

STATE OF TEXAS §

COUNTY OF DALLAS §
COUNTY OF TARRANT §

I, Donna J. Schnell, Board Staff Secretary of the Dallas Fort Worth International Airport Board, do hereby certify that the attached is a true and correct copy of Resolution No. 2022-06-121, approved by the Dallas-Fort Worth International Airport Board of Directors at its Board Meeting held on June 2, 2022.

WITNESS MY HAND AND SEAL OF THE DALLAS-FORT WORTH INTERNATIONAL AIRPORT BOARD, this 13^h day of September 2022.

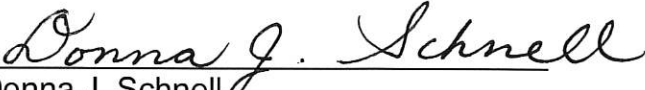
Donna J. Schnell
Board Staff Secretary

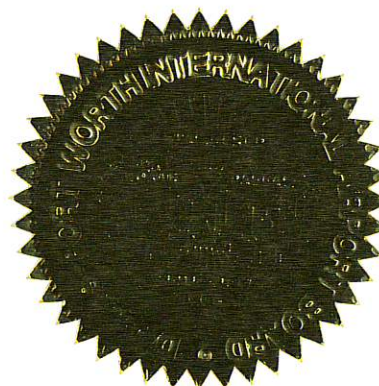

**DALLAS FORT WORTH INTERNATIONAL AIRPORT BOARD
OFFICIAL BOARD ACTION/RESOLUTION**

Date 06/02/2022	Committee Operations	Subject Amend Construction and Fire Prevention Standards	Resolution # 2022-06-121
---------------------------	--------------------------------	--	------------------------------------

Action
That the Board approves amendments to the Construction and Fire Prevention Standards and Codes, as set forth in Exhibit A attached, and further recommends to the Cities of Dallas and Fort Worth that they approve such amendments.

Description

- Approve amendments to the Construction and Fire Prevention Standards to adopt the State Adopted Electrical Code and certain 2021 series model codes published by the International Code Council, Inc., (ICC) as listed in Exhibit A, each with proposed local amendments.

Justification

- Model codes set minimum requirements for building design, construction and operation to protect public health, safety and the natural resources that sustain us.
- The International Codes are developed with several goals in mind; to safeguard public health, safety and welfare and to provide for the safety of firefighters and emergency responders.
- Updated model construction and fire codes are adopted from time to time to ensure the health, safety and welfare of the public and to stay current with state and federal regulations.

D/S/M/WBE Information

- Not Applicable

Contract #	Agreement #	Purchase Order #	Action Amount \$0	Revised Amount \$0
-------------------	--------------------	-------------------------	-----------------------------	------------------------------

For Information contact Tammy Huddleston 3-6132	Fund	Project #	External Funding Source	Amount \$0
--	-------------	------------------	--------------------------------	----------------------

Additional Information

- On October 29, 2015, by Resolution No. 2015-11-224, the Board approved Amendments to the Construction and Fire Prevention Standards and Codes.

Additional Attachments: **Y**

BE IT RESOLVED BY THE DALLAS FORT WORTH INTERNATIONAL AIRPORT BOARD

That the Board approves amendments to the Construction and Fire Prevention Standards and Codes, as set forth in Exhibit A attached, and further recommends to the Cities of Dallas and Fort Worth that they approve such amendments.

Approved as to Form by



Rodriguez, Elaine
Legal Counsel
May 18, 2022 5:04 pm

Approved as to Funding by

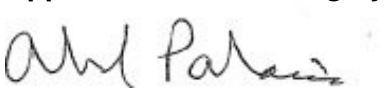

Palacios, Abel
Vice President Finance
Finance
May 18, 2022 5:26 pm

Approved as to M/WBE by



Burks Lee, Tamela
Vice President Business Diversity
and Development
Business Diversity and
Development
May 19, 2022 9:56 am

SIGNATURE REQUIRED FOR APPROVAL

Approved by



Department Head
May 18, 2022 12:55 pm



Chief Executive Officer

Jun 3, 2022 4:58 pm
Date

EXHIBIT A

DALLAS-FORT WORTH INTERNATIONAL AIRPORT

CONSTRUCTION AND FIRE PREVENTION STANDARDS RESOLUTION

AND

AMENDMENTS TO THE CODES

~~October 2021~~

TABLE OF CONTENTS

PART ONE -- CONSTRUCTION AND FIRE PREVENTION STANDARDS

RESOLUTION 1

SECTION 1 TITLE 1

SECTION 2 PURPOSE 1

SECTION 3 CREATION OF BOARD OF APPEALS (BOA)..... 2

SECTION 4 COMPOSITION OF BOA 2

SECTION 5 EX-OFFICIO MEMBERS..... 4

SECTION 6 MEETINGS: QUORUM 4

SECTION 7 BYLAWS AND RECORDS..... 4

SECTION 8 AUTHORITY AND POWER..... 5

SECTION 9 RIGHT OF APPEAL..... 5

SECTION 10 AGENDA AND RECORDS..... 6

SECTION 11 HEARING 6

SECTION 12 STAY OF PROCEEDINGS..... 6

SECTION 13 2021 INTERNATIONAL BUILDING CODE ADOPTED 6

SECTION 2021 INTERNATIONAL EXISTING BUILDING CODE ADOPTED..... 6

SECTION 14 2021 INTERNATIONAL FIRE CODE ADOPTED..... 7

SECTION 15 2020 NATIONAL ELECTRICAL CODE ADOPTED 7

SECTION 16 2020 INTERNATIONAL MECHANICAL CODE ADOPTED..... 7

SECTION 17 2021 INTERNATIONAL PLUMBING CODE ADOPTED..... 7

SECTION 18 2021 INTERNATIONAL FUEL GAS CODE ADOPTED 7

SECTION 19 2021 INTERNATIONAL ENERGY CONSERVATION CODE ADOPTED .. 8

SECTION 20 REQUIRED PERMITS 8

SECTION 21 REQUIRED FEES 8

SECTION 22 LICENSES REQUIRED 8

SECTION 23 ENFORCEMENT..... 9

SECTION 24 SPECIAL ENACTMENT..... 9

SECTION 25 CONFLICTING PROVISIONS..... 9

SECTION 26 SEVERABILITY CLAUSE 9

SECTION 27 PENAL CLAUSE..... 10

SECTION 28 SAVINGS CLAUSE..... 10

SECTION 29 PUBLICATION..... 10

SECTION 30 EFFECTIVE DATE..... 10

PART TWO – BUILDING CODE AMENDMENTS 1

SECTION 101 GENERAL..... 1

SECTION 102 EXISTING STRUCTURES 1

SECTION 103 DEPARTMENT OF BUILDING SAFETY..... 1

SECTION 105 PERMITS	2
SECTION 106 FLOOR AND ROOF DESIGN LOADS	2
SECTION 109 FEES.....	2
SECTION 111 CERTIFICATE OF OCCUPANCY.....	2
SECTION 113 BOARD OF APPEALS.....	2
SECTION 114 VIOLATIONS	3
SECTION 202 DEFINITIONS	3
SECTION 402 COVERED MALLS AND OPEN MALL BUILDING	3
SECTION 403 HIGH-RISE BUILDINGS	5
SECTION 412 AIRCRAFT RELATED OCCUPANCIES	6
SECTION 903 AUTOMATIC SPRINKLER SYSTEMS.....	6
SECTION 907 FIRE ALARM AND DETECTION SYSTEMS	7
SECTION 1003 GENERAL MEANS OF EGRESS.....	8
SECTION 1004 OCCUPANT LOAD.....	9
SECTION 1010 DOORS, GATES, AND TURNSTILES.....	9
SECTION 1023 INTERIOR EXIT STAIRWAYS AND RAMPS	9
SECTION 1025 LUMINOUS EGRESS PATH MARKINGS	10
CHAPTER 11 ACCESSIBILITY	10
SECTION 3002 HOISTWAY ENCLOSURES.....	10
CHAPTER 35 REFERENCED STANDARDS.....	10
ADOPTION OF APPENDIX CHAPTER H SIGNS.....	11

PART THREE – FIRE CODE AMENDMENTS **1**

SECTION 101 SCOPE AND GENERAL REQUIREMENTS	1
SECTION 102 APPLICABILITY	1
SECTION 103 DEPARTMENT OF FIRE PREVENTION	1
SECTION 105 PERMITS	1
SECTION 107 MAINTENANCE.....	2
SECTION 108 BOARD OF APPEALS.....	2
SECTION 109 VIOLATIONS	2
SECTION 202 DEFINITIONS	2
SECTION 307 OPEN BURNING, RECREATIONAL FIRES AND PORTABLE OUTDOOR FIREPLACES.....	3
SECTION 503 FIRE APPARATUS ACCESS ROADS	4
SECTION 507 FIRE PROTECTION WATER SUPPLIES.....	5
SECTION 903 AUTOMATIC SPRINKLER SYSTEMS.....	10
SECTION 907 FIRE ALARM AND DETECTION SYSTEMS	12
SECTION 1003 GENERAL MEANS OF EGRESS.....	13
SECTION 1004 OCCUPANT LOAD.....	13
SECTION 1023 INTERIOR EXIT STAIRWAYS AND RAMPS	14
SECTION 5005 USE, DISPENSING AND HANDLING	14
SECTION 5704 STORAGE	14
CHAPTER 80 REFERENCED STANDARDS.....	15
ADOPTION OF APPENDIX CHAPTERS.....	15

PART FOUR – ELECTRICAL CODE AMENDMENTS	1
<hr/>	
ARTICLE 89 TITLE	1
PART FIVE - MECHANICAL CODE AMENDMENTS	1
<hr/>	
SECTION 101 GENERAL.....	1
SECTION 103 DEPARTMENT OF MECHANICAL INSPECTION	1
SECTION 106 PERMITS	1
SECTION 108 VIOLATIONS	1
SECTION 109 MEANS OF APPEAL	1
PART SIX - PLUMBING CODE AMENDMENTS	1
<hr/>	
SECTION 101 GENERAL.....	1
SECTION 103 DEPARTMENT OF PLUMBING INSPECTION.....	1
SECTION 106 PERMITS	1
SECTION 108 VIOLATIONS	1
SECTION 109 MEANS OF APPEAL	1
SECTION 312 TESTS AND INSPECTIONS.....	2
TABLE 403.1 MINIMUM NUMBER OF REQUIRED PLUMBING FACILITIES	2
SECTION 404 ACCESSIBLE PLUMBING FACILITIES.....	2
SECTION 1106 SIZES OF CONDUCTORS, LEADERS AND STORM DRAINS.....	2
SECTION 1109 COMBINED SANITARY AND STORM SYSTEM	3
PART SEVEN - FUEL GAS CODE AMENDMENTS	1
<hr/>	
SECTION 101 GENERAL.....	1
SECTION 103 DEPARTMENT OF INSPECTION	1
SECTION 106 PERMITS	1
SECTION 108 VIOLATIONS	1
SECTION 109 MEANS OF APPEAL	2
PART EIGHT - ENERGY CODE AMENDMENTS	1
<hr/>	
SECTION C101 SCOPE AND GENERAL REQUIREMENTS.....	1
SECTION C110 VIOLATION PENALTIES.....	1
SECTION 202 GENERAL DEFINITIONS.....	1

PART NINE – OIL AND GAS EXPLORATION AND PRODUCTION **1**

SECTION 1 GENERAL INFORMATION 1
SECTION 2 DEFINITIONS 1
SECTION 3 AIRPORT OVERSIGHT 4
SECTION 4 OPERATOR’S AGENT 5
SECTION 5 SEISMIC SURVEY PERMIT REQUIREMENTS 5
SECTION 6 GAS WELL AND DISPOSAL WELL PERMIT REQUIREMENTS..... 6
SECTION 7 PERMIT APPLICATION 7
SECTION 8 PERMITTING PROCEDURE..... 10
SECTION 9 AMENDED GAS WELL PERMITS 10
SECTION 10 SUSPENSION OR REVOCATION OF WELL PERMITS 11
SECTION 11 PERIODIC REPORTS..... 12
SECTION 12 BOND, LETTERS OF CREDIT, INDEMNITY INSURANCE 13
SECTION 13 SETBACK REQUIREMENTS 16
SECTION 14 ON SITE AND TECHNICAL REGULATIONS 17
(A)SECTION 15 SCREENING 27
SECTION 16 CLEANUP AND MAINTENANCE 29
SECTION 17 PLUGGED AND ABANDONED WELLS 30
SECTION 18 TECHNICAL ADVISOR 31
SECTION 19 MEANS OF APPEAL 31
SECTION 20 VARIANCE RESOLUTION COMMITTEE..... 31
SECTION 21 SEVERABILITY CLAUSE 33

PART ONE -- CONSTRUCTION AND FIRE PREVENTION STANDARDS RESOLUTION

A Board Resolution creating the Board of Appeals (BOA) of the Dallas-Fort Worth International Airport (the Airport); providing for the selection and term of office of members; providing for public hearings, meetings and procedures therefore; prescribing the authority and powers of the Board of Appeals; providing for appeal from decisions of the Building Official and Fire Chief; providing for a stay of proceedings upon appeal; providing for the adoption of the Building Code; providing for the adoption of the Fire Code; providing for the adoption of the Electrical Code; providing for the adoption of the Mechanical Code; providing for the adoption of the Plumbing Code; providing for the adoption of the Fuel Gas Code; providing for the adoption of the Energy Code; providing for the regulation of oil and gas exploration and production; making it unlawful to perform construction work or oil and gas exploration and production without a permit; making it unlawful to undertake the contracted installation of fire protection, mechanical, plumbing, irrigation or electrical equipment without a proper license to do such work; providing for the termination of the Board of Airport Building Code of Appeals; providing that this resolution shall be cumulative; providing a severability clause; providing a penal clause; providing a savings clause; providing for publication in pamphlet form; providing for publication in a newspaper; and providing an effective date.

SECTION 1 TITLE

This resolution shall be known as the Dallas-Fort Worth International Airport Construction and Fire Prevention Standards Resolution, and referred to herein as (this Resolution).

SECTION 2 PURPOSE

It is the specific intent of the Dallas-Fort Worth International Airport Board (the Airport Board) that standards for construction and fire prevention be used for the health, safety and welfare of all persons at the Airport. The Airport Board finds that construction and fire prevention standards change from time to time and that these standards should stay current with modern practices of construction and fire safety. In carrying out these purposes, it is the intent of the Airport Board that such construction and fire prevention standards be adopted as outlined herein and that a Board of Appeals (BOA) be given limited authority over matters pertaining thereto. The scope of the BOA is as set forth below.

It is the intent of the Airport Board that compliance with the construction and fire prevention standards contained herein is the responsibility of those persons and businesses to which they apply; and that neither the BOA nor the Airport Board, its

members, agents and employees, shall be liable or responsible for any errors or omissions arising out of the enforcement or failure to enforce these standards.

SECTION 3 CREATION OF BOARD OF APPEALS (BOA)

The Airport Board hereby establishes a Board of Appeals (BOA) for the purpose of determining the acceptability and adequacy of materials, equipment and methods of construction and for interpretation of these standards. The Airport Board shall adopt construction and fire prevention standards, which will be applicable throughout the Airport. The Construction and Fire Prevention Standards shall include but not be limited to the Building Code, Fire Code, Electrical Code, Mechanical Code, Plumbing Code, Fuel Gas Code and Energy Code and Part Nine of this Resolution for Oil and Gas Exploration and Production as adopted by the Airport Board and amended from time to time.

SECTION 4 COMPOSITION OF BOA

The BOA shall consist of seven voting members who shall serve without compensation and shall be selected in the following manner:

Place 1: An architect, registered to practice as an architect in the State of Texas - The selection of the architect shall be made alternatively ~~by the Dallas and Fort Worth Chapters of the American Institute of Architects~~ and shall be confirmed by the Airport Board. The initial term will be filled by a selection of the Dallas Chapter and will extend from the Airport Board's confirmation of the selection through December 31, 1990. Thereafter, terms will be for two years extending from January 1 of odd-numbered years through December 31 of even-numbered years.

Place 2: An electrical engineer, registered to practice as a professional engineer in the State of Texas whose practice is or has been the design of electrical systems for buildings - The selection of the electrical engineer ~~shall be made alternatively by the Dallas and Fort Worth Chapters of the Texas Society of Professional Engineers~~ and shall be confirmed by the Airport Board. The initial term will be filled by a selection of the Fort Worth Chapter and will extend from the Airport Board's confirmation of the selection through December 31, 1990. Thereafter, terms will be for two years extending from January 1 of odd-numbered years through December 31 of even-numbered years.

Place 3: A mechanical engineer, registered to practice as a professional engineer in the State of Texas whose practice is or has been the design of mechanical systems for buildings - The selection of the mechanical engineer shall be ~~made alternatively by the Dallas and Fort Worth~~

~~Chapters of the Texas Society of Professional Engineers and~~ shall be confirmed by the Airport Board. The initial term will be filled by a selection of the Fort Worth Chapter and will extend from the Airport Board's confirmation of the selection through December 31, 1991. Thereafter, terms will be for two years extending from January 1 of even-numbered years through December 31 of odd-numbered years.

Place 4: A structural engineer, registered to practice as a professional engineer in the State of Texas whose practice is or has been the design of structural systems for buildings - The selection of the structural engineer shall be made alternatively by the Dallas and Fort Worth Chapters of the Texas Society of Professional Engineers and shall be confirmed by the Airport Board. The initial term will be filled by a selection of the Fort Worth Chapter and will extend from the Airport Board's confirmation of the selection through December 31, 1991. Thereafter, terms will be for two years extending from January 1 of even-numbered years through December 31 of odd-numbered years.

Place 5: A fire protection specialist - The selection of the fire protection specialist shall be made by the Dallas/Fort Worth Chapter of the Society of Fire Protection Engineers and shall be confirmed by the Airport Board. The initial term will extend from the Airport Board's confirmation of the selection through December 31, 1991. Thereafter, terms will be for two years extending from January 1 of even-numbered years through December 31 of odd-numbered years.

Place 6: A design professional, registered to practice as an architect or as a professional engineer in the State of Texas, and whose profession relates to the design of facilities, structures or systems that are constructed – The selection of the design professional for Place 6 shall be made by the Dallas Metroplex Alumni Extension Chapter of the National Society of Black Engineers and shall be confirmed by the Airport Board. The initial term shall extend from the Airport Board's confirmation of the selection through December 31, 2005. Thereafter, terms will be for two years extending from January 1 of even-numbered years through December 31 of odd-numbered years.

Place 7: A design professional registered to practice as an architect or as a professional engineer in the State of Texas, and whose profession relates to the design of facilities, structures or systems that are constructed – The selection of the design professional for Place 7 shall be made by the Dallas Fort Worth Chapter of the Society of Hispanic Professional Engineers and shall be confirmed by the Airport Board. The initial term will extend from the Airport Board's confirmation of the selection through December 31, 2004.* Thereafter, terms will be for two years extending

from January 1 of odd-numbered years through December 31 of even-numbered years.

There is no limit on the number of terms an individual may serve on the BOA; however, only in Places 5, 6 and 7 may an individual serve in consecutive terms. Any term scheduled to end on December 31, shall be automatically extended until a successor for that place is selected, confirmed, and sworn in.

In the event that any professional organization, designated to select a candidate to fill a term on the BOA, is unable to make such a selection, and the professional organization notifies the Building Official that a selection cannot be made, then the Building Official shall designate the unfilled seat as officially vacant, and it shall remain vacant until the next scheduled term for that seat.

SECTION 5 EX-OFFICIO MEMBERS

The Building Official and the Fire Chief or their designated representatives shall be ex-officio non-voting members of the BOA. The BOA may make recommendations through the Building Official or Fire Chief to the Airport Board for amendments to the standards accordingly.

The Building Official of the Dallas/Fort Worth International Airport Board is the official in charge of the Code Compliance Section of the Design, Code & Construction Department.

The Director of the Department of Public Safety of the Dallas/Fort Worth International Airport Board or his designee is hereby designated as the Fire Chief.

SECTION 6 MEETINGS: QUORUM

All meetings of the BOA shall be open to the public except as permitted by law and as is in the interest of the Airport. Three (3) members of the BOA shall constitute a quorum to transact business. Every matter before the BOA for vote shall require for final passage the affirmative vote of a majority of the members present and voting. The first meeting of the BOA following its appointment shall be at such time and place as called by the Building Official. Thereafter the BOA shall hold meetings at such time and place as called by the Chairman or one lawfully acting in that capacity.

SECTION 7 BYLAWS AND RECORDS

At its first meeting the BOA shall elect one of its members as Chairman, and he shall keep a record of the proceedings and decisions, and a copy of same shall be filed in the office of the Building Official. Each year thereafter, following the Airport Board's

confirmation of the composition of the BOA, the BOA shall hold an organizational meeting, at which time it shall elect a Chairman before proceeding to other matters of business. The BOA shall establish its own rules of procedure and shall amend them from time to time as it deems necessary. The Building Official shall serve as Secretary to the BOA.

SECTION 8 AUTHORITY AND POWER

The BOA shall have the authority and power to:

1. Hear appeals on interpretations by the Building Official of the Building Code, Electrical Code, Mechanical Code, Plumbing Code, Fuel Gas Code and Energy Code. The BOA may modify in whole or in part or may affirm the interpretation of the Building Official. The Building Official shall render a written interpretation within thirty (30) days of a request by a person who has been aggrieved by a decision of the Building Official. No interpretations shall be heard by the BOA until the Building Official has rendered a written interpretation.

2. Hear appeals on interpretations by the Fire Chief of the Fire Code. The BOA may modify in whole or in part or may affirm the interpretation of the Fire Chief. The Fire Chief shall render a written interpretation within thirty (30) days of a request by a person who has been aggrieved by a decision of the Fire Chief. No interpretations shall be heard by the BOA until the Fire Chief has rendered a written interpretation.

3. Approve alternate methods of construction and fire prevention where it is impractical to meet the adopted construction and fire prevention standards, provided that the BOA finds the same degree of suitability, strength, effectiveness, fire resistance, durability, sanitation and safety exists in the alternate method as intended by the standards.

4. Approve new methods of construction and fire prevention not covered by the construction and fire prevention standards, provided that the BOA finds the same degree of suitability, strength, effectiveness, fire resistance, durability, sanitation and safety exists in the new method as intended by the standards.

The BOA shall have no power to otherwise limit, modify or change these construction and fire prevention standards.

SECTION 9 RIGHT OF APPEAL

Any person, firm, company or corporation aggrieved by any decision or order of the Building Official or Fire Chief may appeal such decision or order to the BOA. Every appeal must be in writing and must be filed in triplicate with the Building Official within thirty (30) days from the date of the decision or order appealed from. The BOA shall

not consider any appeal that is filed after the thirty (30) day period. Such appeal shall contain appropriate reference to the decision or order appealed from, as well as the grounds for the appeal.

SECTION 10 AGENDA AND RECORDS

The agenda for the BOA shall be prepared by the Building Official and shall be posted as required by law. All records and evidence pertinent to any appeal shall be transmitted to the BOA and to the aggrieved party prior to the hearing. Records of all appeals shall be kept in the office of the Building Official. The Building Official shall transmit copies of appeal records to the Fire Chief.

SECTION 11 HEARING

The BOA shall fix a reasonable time for the hearing of an appeal and shall give notice of the hearing in writing to the parties in interest. Parties may appear before the BOA in person, by agent or by attorney. The BOA shall establish rules for the fair and efficient conduct of the hearing and the just resolution to an appeal. The BOA shall notify the appellant of its decision.

SECTION 12 STAY OF PROCEEDINGS

An appeal shall stay all proceedings in connection with the decision or order appealed from, unless and until the Building Official or Fire Chief shall have certified to the BOA after notice of appeal has been filed that a stay would cause an unreasonable risk of harm to life or damage to property. Any work done contrary to the order of the Building Official or Fire Chief after filing an appeal hereunder, pending the determination of such appeal, shall be subject to removal or repair should the order be affirmed. The cost of removal or repair of the work done shall be borne solely by the person, firm, company or corporation who was responsible for the work without consideration of mitigating or extenuating circumstances.

SECTION 13 2021 INTERNATIONAL BUILDING CODE ADOPTED

The Building Code of the Dallas-Fort Worth International Airport Board is hereby revised and amended to conform to the 2021 International Building Code of the International Code Council, Inc. except as amended by separate exhibit attached hereto and is hereby adopted as the Building Code and forms a part of the Construction and Fire Prevention Standards from the effective date hereof.

SECTION
2021 INTERNATIONAL EXISTING BUILDING CODE ADOPTED

The Existing Building of the Dallas-Fort Worth International Airport Board is hereby revised and amended to conform to the 2021 International Existing Building Code of the International Code Council, Inc. except as amended by separate exhibit attached hereto and is hereby adopted as the Existing Building Code and forms a part of the Construction and Fire Prevention Standards from the effective date hereof

SECTION 14
2021 INTERNATIONAL FIRE CODE ADOPTED

The Fire Code of the Dallas-Fort Worth International Airport Board is hereby revised and amended to conform to the 2021 International Fire Code, except as further amended by separate exhibit attached hereto and is hereby adopted as the Fire Code and forms a part of the Construction and Fire Prevention Standards from the effective date hereof.

SECTION 15
2020 NATIONAL ELECTRICAL CODE ADOPTED

The Electrical Code of the Dallas-Fort Worth International Airport Board is hereby revised and amended to conform to the 2020 National Electrical Code (NFAP 70) of the National Fire Protection Association except as amended by separate exhibit attached hereto and together are hereby adopted as the Electrical Code and form a part of the Construction and Fire Prevention Standards from the effective date hereof.

SECTION 16
2021 INTERNATIONAL MECHANICAL CODE ADOPTED

The Mechanical Code of the Dallas-Fort Worth International Airport Board is hereby revised and amended to conform to the 2021 International Mechanical Code of the International Code Council, Inc. except as amended by separate exhibit attached hereto and is hereby adopted as the Mechanical Code and forms a part of the Construction and Fire Prevention Standards from the effective date hereof.

SECTION 17
2021 INTERNATIONAL PLUMBING CODE ADOPTED

The Plumbing Code of the Dallas-Fort Worth International Airport Board is hereby revised and amended to conform to the 2021 International Plumbing Code of the International Code Council, Inc. except as amended by separate exhibit attached hereto and is hereby adopted as the Plumbing Code and forms a part of the Construction and Fire Prevention Standards from the effective date hereof.

SECTION 18
2021 INTERNATIONAL FUEL GAS CODE ADOPTED

The Fuel Gas Code of the Dallas-Fort Worth International Airport Board is hereby revised and amended to conform to the 2021 International Fuel Gas Code of the International Code Council, Inc. except as amended by separate exhibit attached hereto and is hereby adopted as the Fuel Gas Code and forms a part of the Construction and Fire Prevention Standards from the effective date hereof.

SECTION 19

2021 INTERNATIONAL ENERGY CONSERVATION CODE ADOPTED

The Energy Code of the Dallas-Fort Worth International Airport Board is hereby revised and amended to conform to the 2021 International Energy Conservation Code of the International Code Council, Inc. except as amended by separate exhibit attached hereto and is hereby adopted as the Energy Code and forms a part of the Construction and Fire Prevention Standards from the effective date hereof.

SECTION 20

REQUIRED PERMITS

The following activities shall not be performed within the boundaries of the Dallas-Fort Worth International Airport unless a permit for such work has first been obtained from the building official.

1. Construction
2. Oil and Gas Exploration and Production
3. Erection or Alteration of Signs

SECTION 21

REQUIRED FEES

All construction projects for which construction permits are required are subject to a construction permit fee and a plan review fee except where otherwise prohibited by law. All permit and plan review fees shall be in accordance with the Construction Permit Fee Schedule found in the DFW Schedule of Charges.

SECTION 22

LICENSES REQUIRED

Contractors providing the following work within the boundaries of Dallas-Fort Worth International Airport shall be licensed respectively for the category of work performed as regulated by the following:

28 TEX. ADMIN. CODE, Part 1, Subchapter E, Fire Extinguisher Rules § 34.511, Fire Extinguisher Licenses

28 TEX. ADMIN. CODE, Part 1, Subchapter F, Fire Alarm Rules § 34.611, Licenses

28 TEX. ADMIN. CODE, Part 1, Subchapter G, Fire Sprinkler Rules § 34.710, Certificates of Registration

The Air Conditioning and Refrigeration Contractor License Law, Title 8, Occupations Code, Chapter 1302

The Plumbing License Law, Occupations Code, Chapter 1301

Irrigators, Occupations Code, Chapter 1903

Electricians, Title 8, Occupations Code, Chapter 1305

SECTION 23 ENFORCEMENT

The Building Official and Fire Chief shall enforce and execute all decisions and orders of the BOA for which they are respectively responsible. Upon adoption by the Airport Board and the City Councils of the Cities of Dallas and Fort Worth, this resolution shall become effective and shall be enforceable in the municipal courts of a municipality within whose boundaries a violation occurs.

SECTION 24 SPECIAL ENACTMENT

The provisions of this Resolution and the Codes which are a part hereof constitute a special enactment in effect only within the boundaries of the Dallas-Fort Worth International Airport, and are adopted in recognition of the unique and special requirements connected with the planning, building, improvement, maintenance, operation, regulation, protection and policing of the Dallas-Fort Worth International Airport. Neither the Resolution nor the Codes shall be construed to waive or set aside any provisions contained in any law of the State of Texas.

SECTION 25 CONFLICTING PROVISIONS

This resolution shall be cumulative of all provisions of previous actions of the Airport Board except where the provisions of this resolution are in direct conflict with the provisions of previous Board Actions, in which event conflicting provisions of such previous Board Actions are hereby repealed.

SECTION 26 SEVERABILITY CLAUSE

It is hereby declared to be the intention of the Airport Board that the sections, paragraphs, sentences, clauses and phrases of this resolution are severable, and if any phrase, clause, sentence, paragraph or section of this resolution shall be declared unconstitutional by the valid judgment or decree of any court of competent jurisdiction such unconstitutionality shall not affect any of the remaining phrases, clauses, sentences, paragraphs and sections of this resolution, since the same would have been enacted by the Airport Board without the incorporation in this resolution of any such unconstitutional phrase, clause, sentence, paragraph or section.

**SECTION 27
PENAL CLAUSE**

Section 8.F. of the 1968 Contract and Agreement, as amended, between the City of Dallas, Texas and the City of Fort Worth, Texas, provides that the Dallas-Fort Worth International Airport Board shall have the power, by a duly adopted order, to adopt and enforce rules and regulations for the orderly, safe efficient and sanitary operation of the airport and to prescribe penalties for the breach of any rule or regulation not to exceed the maximum fines authorized by state law. State law currently authorizes fines of up to \$500 for all violations of the airport's rules and regulations, except for those violations relating to fire safety, public health and sanitation, or the dumping of refuse, for which the maximum fine is \$2,000, and except when another fine is fixed by state law. Each day that a violation is permitted to exist shall constitute a separate offense.

**SECTION 28
SAVINGS CLAUSE**

All rights and remedies of the Airport Board are expressly saved as to any and all violations of the provisions of the Building Code, the Fire Code or any other codes affecting construction or fire prevention which have accrued at the time of the effective date of this resolution and, as to such accrued violations and all pending litigation, both civil and criminal, whether pending in court or not, under such codes, same shall not be affected by this resolution but may be prosecuted until final disposition by the courts.

**SECTION 29
PUBLICATION**

The Building Official is hereby authorized to publish this resolution in pamphlet form for general distribution among the public, and the operative provisions of this resolution as so published shall be admissible in evidence in all courts without further proof than the production thereof. The Building Official is hereby directed to publish a caption of this Resolution which summarizes the purposes thereof for two (2) days in major newspapers of the Cities of Dallas and Fort Worth Texas, as authorized by V.T.C.A., Local Government Code '52.013.

**SECTION 30
EFFECTIVE DATE**

This resolution shall be in full force and effect from and after its passage and publication as required by law and it is so ordained.

PART TWO – BUILDING CODE AMENDMENTS

**SECTION 101
GENERAL**

101.1 Title. The [2021](#) International Building Code as amended herein is the Building

Code of Dallas-Fort Worth International Airport. References to the International Building Code shall be construed to reference the Building Code as adopted herein with its local amendments.

Amend Section 101.4 to read as follows:

101.4 Referenced codes. The other codes listed in Sections 101.4.1 through 101.4.7 (except 101.4.4 and 101.4.7) and referenced elsewhere in this code, when specifically adopted, shall be considered part of the requirements of this code to the prescribed extent of each such reference.

101.4 Referenced codes.

The other codes specified in [Sections 101.4.1 through 101.4.7](#) and referenced elsewhere in this code shall be considered to be part of the requirements of this code to the prescribed extent of each such reference.

101.4.4 Property maintenance.

The provisions of the [International Property Maintenance Code](#) shall apply to *existing structures* and premises; equipment and facilities; light, *ventilation*, space heating, sanitation, life and fire safety hazards; responsibilities of *owners*, operators and occupants; and occupancy of existing premises and structures.

101.4.7 Existing buildings.

The provisions of the [International Existing Building Code](#) shall apply to matters governing the *repair, alteration, change of occupancy, addition* to and relocation of *existing buildings*.

**SECTION 102
EXISTING STRUCTURES**

Amend Section 102.6 to read as follows:

102.6 Existing structures. The legal occupancy of any structure existing on the date of adoption of this code shall be permitted to continue without change, except as specifically covered in this code or the Fire Code, or as is deemed necessary by the building official for the general safety and welfare of the occupants and the public.

**SECTION 103
DEPARTMENT OF BUILDING SAFETY**

Amend Section 103.1 as follows:

103.1 Creation of enforcement agency. The Department of Building Safety is hereby created, and the official in charge thereof shall be known as the building official. References to the Department of Building Safety shall mean the Code Compliance

**SECTION 105
PERMITS**

105.1 Required. Refer to Part One, Section 20 for general permit requirements. Any owner or authorized agent who intends to construct, enlarge, alter, repair, move, demolish or change the occupancy of a building or structure, or to erect, install, enlarge, alter, repair, remove, convert or replace any electrical, gas, mechanical or plumbing system, the installation of which is regulated by this code, or to cause any such work to be done, shall first make application to the building official and obtain the required permit.

**SECTION 106
FLOOR AND ROOF DESIGN LOADS**

106.1 Live loads posted. Where the live loads for which each floor or portion thereof of a commercial or industrial building is or has been designed to exceed 50 psf (2.40 kN/m²), such design live loads, when required by the building official, shall be posted by the owner in that part of each story in which they apply, using durable signs. It shall be unlawful to remove or deface such notices.

**SECTION 109
FEES**

109.2 Schedule of permit fees. On buildings, structures, electrical, gas, mechanical and plumbing systems or alterations requiring a permit, a fee for each permit shall be paid as required, in accordance with the Construction Permit Fee Schedule found in the DFW Airport Schedule of Charges.

**SECTION 111
CERTIFICATE OF OCCUPANCY**

111.2 Certificate issued. After the building official inspects the building or structure and finds no violations of this code or other laws that are enforced by the department of building safety, the building official shall issue a certificate that contains, as deemed necessary, the following:

**SECTION 113
BOARD OF APPEALS**

Section 113.1 – Board of Appeals Refer to Part One, Construction and Fire Prevention Standards Resolution for Board of Appeals.

SECTION 114 VIOLATIONS

Refer to Part One, Construction and Fire Prevention Standards Resolution, Section 27, Penal Clause.

SECTION 202 DEFINITIONS

ADDRESSABLE FIRE DETECTION SYSTEM. Any fire alarm system capable of providing identification of each individual alarm initiating device. The identification shall be in clear English and shall identify the type and location of the device in alarm. The system shall have the ability of alarm verification.

Following the definition of **AGRICULTURE BUILDING**, add the following definition:

AIRPORT. Airport is the area within the boundaries of the Dallas-Fort Worth International Airport.

ANALOG INTELLIGENT ADDRESSABLE FIRE DETECTION SYSTEM. Any system capable of calculating a change in value by directly measurable quantities (voltage, resistance, etc.) at the sensing point. The physical analog may be conducted at the sensing point or at the main control panel. The system shall be capable of compensating for long-term changes in sensor response while maintaining a constant sensitivity. The compensation shall have a preset point at which a detector maintenance signal shall be transmitted to the control panel. The sensor shall remain capable of detecting and transmitting an alarm while in maintenance alert.

HIGH-RISE BUILDING. A building with an occupied floor located more than 55 feet (16 764 mm) above the lowest level of fire department vehicle access.

SECTION 402 COVERED MALLS AND OPEN MALL BUILDINGS

402.3

Exception: DFW International Airport Terminal Buildings.

402.4.2.1

Exceptions:

1. All tenants whose activities are directly related to terminal operations and purpose. This shall include, but not be limited to airline ticketing, airline offices, baggage handling and gate operations.

2. Concession and other tenants within transportation terminals that use a common, open return-air system for the HVAC operations, when approved by the building official.
3. Food courts within transportation terminals shall be considered one tenant.

402.8 Means of egress. *Covered mall buildings, open mall buildings* and each tenant space within a *mall* building shall be provided with a *means of egress* as required by this section and this code. Where there is a conflict between the requirements of this code and the requirements of Sections 402.8.1 through 4.2.8.8 shall apply.

Exception: Transportation terminals “A”, “B”, “C” and “E” at DFW International Airport shall be allowed to maintain the current egress plans which allow a maximum of 250 feet from the most remote within the terminals to an exit. Terminal “D” shall maintain the maximum egress distance allowed from the most current, approved Terminal D Fire Strategy. Other provisions found in Chapter 10 shall be applicable for egress.

402.8.1 Mall Width. For the purpose of providing required egress, *malls* are permitted to be considered as *corridors* but need not comply with the requirements of Section 1005.1 of this code where the width of the mall is as specified in this section. In the transportation terminals at DFW International Airport the *mall* width shall be defined as the identified concourse width.

402.8.1.1 Minimum Width. The aggregate clear egress width of the mall in either a covered or open mall building shall be not less than 20 feet (6096 mm). The mall width shall be sufficient to accommodate the occupant load served. No portion of the minimum required aggregate egress width shall be less than 10 feet (3048 mm) measured to a height of 8 feet (2438 mm) between any projection of a tenant space bordering the mall and the nearest kiosk, vending machine, bench, display opening, food court or other obstruction to means of egress travel.

Exception: The terminal buildings at DFW International Airport in existence and in operation of the date of the adoption of this code that have concourse width of less than 20 feet shall be allowed to maintain the existing concourse width.

402.8.6

Exceptions:

1. Access to exits are permitted by way of a dead-end mall which does not exceed a length equal to twice the width of the mall measured at the narrowest location within the dead-end portion of the mall.

2. Terminal buildings at DFW International Airport in existence and in operation on the date of the adoption of this code shall be allowed to retain the exit configuration currently in operation. Any changes in this configuration shall meet the above criteria.

SECTION 403 HIGH-RISE BUILDINGS

Applicability add the following exception

Exceptions:

6. Train platforms for fixed guideway transit systems in accordance with Section 412.10.

SECTION 412 AIRCRAFT RELATED OCCUPANCIES

Add new section 412.9 as follows:

Aircraft fueling ramp drainage and aircraft loading walkways. Except for references to airport terminal buildings, comply with NFPA 415, 2014 Edition for aircraft fueling ramp drainage and aircraft loading walkways.

Exceptions:

1. Attached or adjacent fixed loading walkways, gate houses and similar structures accessory to airport terminal buildings may be constructed of Type II-A Construction, provided the floor area of individual structures does not exceed 500 square feet. An approved automatic sprinkler system in accordance with Section 903.3.1.1 shall be allowed to be substituted for 1-hour fire-resistance-rated construction. If the automatic sprinkler system substitution is provided, exterior walls of such structures shall not be required to be of 1-hour fire-resistance-rated construction and openings in such walls shall not be required to be protected.
2. Canopies over baggage conveyors attached to or adjacent to airport terminal buildings may be of Type II-B Construction.

412.10 Fixed guideway transit systems. Fixed guideway transit systems shall comply with NFPA 130, 2014 Edition.

SECTION 903 AUTOMATIC SPRINKLER SYSTEMS

Buildings 55 feet or more in height. An *automatic sprinkler system* shall be installed throughout buildings with a floor level other than penthouses, that is located 55 feet (16 764 mm) or more above the lowest level of fire department vehicle access.

Exception:

Open parking structures.

High-piled combustible storage. For any building with a clear height exceeding 12 feet (4572 mm), see Chapter 23 of the International Fire Code to determine if those provisions apply.

Buildings with floor areas exceeding 4,000 square feet. An automatic sprinkler system shall be installed throughout all buildings with a building area exceeding 4,000 square feet. For purposes of this provision, fire walls shall not define separate buildings.

Exception:

1. Open parking garages

Self-service storage facilities. An approved automatic sprinkler system shall be installed throughout all self-storage facilities.

Exception:

Open parking garages

SECTION 907 FIRE ALARM AND DETECTION SYSTEMS

Add the following two paragraphs after the exceptions under Section 907.2:

All buildings or occupancies, occupied, operated, maintained or monitored by the Dallas-Fort Worth International Airport Board shall have a complete operational manual and automatic fire alarm system in accordance with this code. The system shall be designed and installed in accordance with the DFW Airport Design Criteria Manual and applicable standards.

All buildings or occupancies, other than those described in the preceding paragraph, hereafter constructed or moved on to the airport and having a total floor area of 1,000 square feet or more, regardless of height or occupant load shall have a complete operational manual and automatic fire alarm system in accordance with the requirements of this code.

Exceptions:

1. Open parking garages may use other approved means for fire

department notification.

2. Temporary structures or buildings erected for less than 365 days when approved by the fire chief.

[F] 907.2.1.1 System initiation in Group A occupancies with an occupant load of 1,000 or more. Activation of the fire alarm in Group A occupancies with an occupant load of 1,000 or more shall initiate a signal using an emergency voice/alarm communications system in accordance with NFPA 72.

Exceptions:

- 1 Where approved, the prerecorded announcement is allowed to be manually deactivated for a period of time, not to exceed 3 minutes, for the sole purpose of allowing a live voice announcement from an *approved, constantly attended location*.
- 2 Where approved by the code official in airport terminal buildings, and where the fire alarm is monitored directly by the Dallas/Fort Worth International Airport Board Department of Public Safety, the activation of the fire alarm notification signal shall be manually initiated by emergency responders.

Amend Section 907.2.13 as follows with the exceptions unchanged:

[F] 907.2.13 High-rise buildings. Buildings having floors used for human occupancy located more than 55 feet (16 764 mm) above the lowest level of fire department vehicle access shall be provided with an automatic smoke detection system in accordance with Section 907.2.13.1, a fire department communication system in accordance with Section 907.2.13.2 and an emergency voice/alarm communication system in accordance with Section 907.5.2.2.

Amend Section 907.4.2 by to read as follows:

[F] 907.4.2 Manual fire alarm boxes. Where a manual fire alarm system is required by another section of this code, it shall be activated by fire alarm boxes installed in accordance with Sections 907.4.2.1 through 907.4.2.5. Manual alarm actuating devices shall be an approved double action type.

[F] 907.4.2.1 Location. Manual fire alarm boxes shall be located not more than 5 feet (1524 mm) from the entrance to each exit.

**SECTION 1003
GENERAL MEANS OF EGRESS**

Add Exception 4 under Section 1003.5 to read as follows:

At entrances to mechanical penthouses from roofed areas, the door sill elevation may be up to 8 inches (203 mm) above the elevation of the

landing on either or both sides of the door.

SECTION 1004 OCCUPANT LOAD

Multiple function occupant load.

Where an area under consideration contains multiple functions having different *occupant load* factors, the design *occupant load* for such area shall be based on the floor area of each function calculated independently

Exception:

Assembly occupancies within airport terminal buildings are not required to have the occupant load posted unless required by the Building Official.

SECTION 1010 DOORS, GATES, AND TURNSTILES

1010.1.9.10 Locking arrangements in correctional facilities and high security hallways in transportation terminals. In occupancies in Groups A-2, A-3, A-4, B, E, F, I-2, M and S within correctional and detention facilities, doors in *means of egress* serving rooms or spaces occupied by persons whose movement are controlled for security reasons shall be permitted to be locked when equipped with egress control devices which shall unlock manually and by at least one of the following means:

1. Activation of an *automatic sprinkler system* installed in accordance with Section 903.3.1.1;
2. Activation of an *approved* manual alarm box; or
3. A signal from a *constantly attended location*.

Doors providing access to high security hallways, including, but limited to employee access, within transportation terminals may be permitted to be locked when equipped with egress control devices which shall unlock manually and by at least one of the means listed above when approved by the building official and fire chief.

SECTION 1023 INTERIOR EXIT STAIRWAYS AND RAMPS

Tactile floor-level signs.

Where floor level signs are provided in *interior exit stairways and ramps*, a floor-level sign identifying the floor level in visual characters, raised characters and braille complying with ICC A117.1 shall be located at each floor-level landing adjacent to the door leading from the *interior exit stairway and ramp* into the corridor.

Exception: Fixed guideway train stations

**SECTION 1025
LUMINOUS EGRESS PATH MARKINGS**

1025.1

Exceptions:

2. Train platforms for fixed guideway transit systems in accordance with Section 412.10.

**CHAPTER 11
ACCESSIBILITY**

Spaces and elements of buildings and facilities shall be designed and constructed to standards consistent with the Texas Accessibility Standards as administered by the Texas Department of Licensing and Regulation, except for the following:

Unisex toilet rooms. Assembly areas shall be provided with one unisex toilet room for each instance where the total fixture count (water closets and urinals) in a set of men and women's toilet rooms exceeds 20 fixtures. In assembly areas of airport terminal buildings, one unisex toilet room shall be provided in each instance where the total fixture count (water closets and urinals) in a set of men and women's toilet rooms exceeds 6 fixtures. The unisex toilet room shall be located adjacent to the men and women's toilet rooms, which are used to determine that the unisex toilet room is required.

**SECTION 3002 HOISTWAY
ENCLOSURES**

3002.4 Elevator car to accommodate ambulance stretcher. Where elevators are provided in buildings four or more stories above grade plane or four or more *stories below grade plane, at least one elevator shall be provided for fire department* emergency access to all floors. The elevator car shall be of such size and arrangement to accommodate a 31- by 90-inch (788 mm by 2286 mm) ambulance stretcher in the horizontal open position and shall be identified by the international symbol for emergency medical services (star of life). The symbol shall not be less than 3 inches (76 mm) high and shall be placed inside on both sides of the hoist way door frame.

**CHAPTER 35
REFERENCED STANDARDS**

NFPA

Standard Reference Number 72-2013

National Fire Alarm Code

ADOPTION OF APPENDIX CHAPTER H SIGNS

Appendix Chapter H – Signs is specifically adopted as part of the Building Code.

Amend Section H101.2 as follows:

H- 101.2 Signs exempt from permits. The following signs are exempt from the requirements to obtain a permit before erection:

1. Signs erected by transportation authorities.
2. The changing of movable parts of an approved sign that is designed for such changes, or the repainting or repositioning of display matter shall not be deemed an alteration.

PART THREE – FIRE CODE AMENDMENTS

SECTION 101 SCOPE AND GENERAL REQUIREMENTS

101.1 Title. The 2021 International Fire Code as amended herein is the Fire Code of Dallas-Fort Worth International Airport. References to International Fire Code shall be construed to reference the Fire Code as adopted herein with its local amendments.

SECTION 102 APPLICABILITY

102.7 Referenced codes and standards. The codes and standards referenced in this code shall be those that are listed in Chapter 80 and such codes and standards, when specifically adopted, shall be considered part of the requirements of this code to the prescribed extent of each such reference. Where differences occur between the provisions of this code and the referenced standards, the provisions of this code shall apply. Whenever amendments have been adopted to the referenced codes and standards, each reference to said code and standard shall be considered to reference the amendments as well.

Conflicts.

Where conflicts occur between provisions of this code and referenced codes and standards, the provisions of this code shall apply.

Provisions in referenced codes and standards.

Where the extent of the reference to a referenced code or standard includes subject matter that is within the scope of this code, the provisions of this code, as applicable, shall take precedence over the provisions in the referenced code or standard.

**SECTION 103
DEPARTMENT OF FIRE PREVENTION**

103.1 General. The department of fire prevention is established within the jurisdiction under the direction of the fire code official. The function of the department shall be the implementation, administration and enforcement of the provisions of this code. References to the department of fire prevention shall mean the Department of Public Safety, Fire Prevention and Planning Office.

**SECTION 105
PERMITS**

105.6.7 Combustible dust-producing operations. Combustible dust-producing operations, as defined in this code, shall be prohibited within the airport.

105.6.19 Fruit and crop ripening. Fruit and crop ripening operations using ethylene or other flammable gases shall be prohibited within the airport.

105.6.35 Organic coatings. The manufacturing of organic coatings, as defined in this code, shall be prohibited within the airport.

Fire pumps and related equipment.

A construction permit is required for installation of or modification to fire pumps and related fuel tanks, jockey pumps, controllers and generators. Maintenance performed in accordance with this code is not considered to be a modification and does not require a construction permit

Pyroxylin plastics. An operational permit is required for storage or handling of any amount of cellulose nitrate (pyroxylin) plastics and for the assembly or manufacture of articles involving pyroxylin plastics.

105.7.19 Electronic access control systems. Construction permits are required for the installation or modification of an electronic access control system, as specified in Chapter 10. A separate construction permit is required for the installation or modification of a fire alarm system that may be connected to the access control system. Maintenance performed in accordance with this code is not considered a modification and does not require a permit.

SECTION 107 MAINTENANCE

Fees for re-inspections or for inspections outside of normal business hours shall be reimbursed as required by the fire chief in accordance with the DFW Airport Schedule of Charges, Development Charges.

SECTION 108 BOARD OF APPEALS

108.1 Board of appeals. Refer to Part One, Construction and Fire Prevention Standards Resolution for Board of Appeals.

SECTION 109 VIOLATIONS

109.4 Violation penalties. Refer to Part One, Construction and Fire Prevention Standards Resolution, Section 27, Penal Clause.

SECTION 202 DEFINITIONS

ADDRESSABLE FIRE DETECTION SYSTEM. Any fire alarm system capable of providing identification of each individual alarm-initiating device. The identification shall be in clear English and shall identify the type and location of the device in alarm. The system shall have the ability of alarm verification.

ANALOG INTELLIGENT ADDRESSABLE FIRE DETECTION SYSTEM. Any system capable of calculating a change in value by directly measurable quantities (voltage, resistance, etc.) at the sensing point. The physical analog may be conducted at the sensing point or at the main control panel. The system shall be capable of compensating for long-term changes in sensor response while maintaining a constant sensitivity. The compensation shall have a preset point at which a detectomaintenance signal shall be transmitted to the control panel. The sensor shall remain capable of detecting and transmitting an alarm while in maintenance alert.

HIGH-PILED COMBUSTIBLE STORAGE. Any building classified as a group S occupancy or Speculative building exceeding 12,000 sq.ft. that has a clear height in excess of 14 feet which permits storage in excess of 12 feet shall be considered high-piled storage.

HIGH-RISE BUILDINGS. Buildings with a floor used for human occupancy located more than 55 feet (16 764 mm) above the lowest level of fire department vehicle access.

REPAIR GARAGE. A building structure or portion thereof used for servicing or

repairing motor vehicles. This definition shall also include garages involved in minor repair, modification and servicing of motor vehicles for items such as oil/lube changes, Inspections, windshield repair or replacement, shocks, minor part replacement and other such minor repairs.

SELF-SERVICE STORAGE FACILITY. Real property designed and used for the purpose of renting or leasing individual storage spaces to customers for the purpose of storing and removing personal property on a self-service basis.

SECTION 307 OPEN BURNING, RECREATIONAL FIRES AND PORTABLE OUTDOOR FIREPLACES

307.4.1 Bonfires. Bonfires shall be prohibited within the airport.

SECTION 404 FIRE SAFETY, EVACUATION AND LOCKDOWN PLANS

4.10 Fire extinguishing system controls.

SECTION 501 GENERAL

501.4 Timing of installation. When fire apparatus access roads or a water supply for fire protection is required for any structure or development, they shall be installed, tested and approved upon the completion of the foundation structure and prior to any additional construction taking place.

SECTION 503 FIRE APPARATUS ACCESS ROADS

503.2.1 Dimensions. Fire apparatus access roads shall have an unobstructed width of not less than 24 feet (7315 mm), exclusive of shoulders, except for approved security gates in accordance with Section 503.6, and an unobstructed vertical clearance of not less than 14 feet (4267 mm).

503.2.2 Authority. The fire code official shall have the authority to require an increase or decrease in the minimum access widths and vertical clearances where they are inadequate for fire or rescue operations.

503.2.3 Surface. Fire apparatus roads shall be designed and maintained to support imposed loads of 82,000 lbs. for fire apparatus and shall be surfaced so as to provide all-weather driving capabilities.

503.3 Marking. Striping, signs, or other markings, when approved by the *fire code official*, shall be provided for fire apparatus access roads to identify such roads or prohibit the obstruction thereof. Striping, signs and other markings shall be maintained in a clean and legible condition at all times and replaced or repaired when necessary to

provide adequate visibility.

(1) Striping – Fire apparatus access roads shall be continuously marked by painted lines of red traffic paint six inches (6”) in width to show the boundaries of the lane. The words “NO PARKING FIRE LANE” or “FIRE LANE NO PARKING” shall appear in four- inch (4”) white letters at 25 feet intervals on the red border markings along both sides of the fire lanes. Where a curb is available, the striping shall be on the vertical face of the curb.

(2) Signs – Signs shall read “NO PARKING FIRE LANE” or “FIRE LANE NO PARKING” and shall be 12” wide and 18” high. Signs shall be painted on a white background with letters and borders in red, using not less than 2” lettering. Signs shall be permanently affixed to a stationary post and the bottom of the sign shall be six feet, six inches (6’6”) above finished grade. Signs shall be spaced not more than fifty feet (50’) apart along both sides of the fire lane. Signs may be installed on permanent buildings or walls or as approved by the Fire Chief.

503.4 Obstruction of fire apparatus access roads. Fire apparatus access roads shall not be obstructed in any manner, including the parking of vehicles. The minimum widths and clearances established in Section 503.2.1 and any area marked as a fire lane as described in Section 503.3 shall be maintained at all times.

SECTION 505 PREMISES IDENTIFICATION

Address identification. New and existing buildings shall be provided with approved address identification. The address identification shall be legible and placed in a position that is visible from the street or road fronting the property. Address identification characters shall contrast with their background. Address numbers shall be Arabic numbers or alphabetical letters. Numbers shall not be spelled out. Each character shall be not less than 6 inches (152.4 mm) high with a minimum stroke width of 1/2 inch (12.7 mm). Where required by the fire code official, address numbers shall be provided in additional approved locations to facilitate emergency response. Where access is by means of a private road, buildings do not immediately front a street, and/or the building cannot be viewed from the public way, a monument, pole or other sign with approved 6 inch (152.4 mm) height building numerals or addresses and 4 inch (101.6 mm) height suite/apartment numerals of a color contrasting with the background of the building or other approved means shall be used to identify the structure. Numerals or addresses shall be posted on a minimum 20 inch (508 mm) by 30 inch (762 mm) background on border. Address identification shall be maintained.

SECTION 507 FIRE PROTECTION WATER SUPPLIES

Water supply test date and information. The water supply test used for hydraulic calculation of fire protection systems shall be conducted in accordance with NFPA 291 “Recommended Practice for Fire Flow Testing and Marking of Hydrants” and within one year of sprinkler plan submittal. The *fire code official* shall be notified prior to the water supply test. Water supply tests shall be witnessed by the *fire code official*, as required.

The exact location of the static/residual hydrant and the flow hydrant shall be indicated on the design drawings. All fire protection plan submittals shall be accompanied by a hard copy of the water flow test report, or as approved by the *fire code official*. The report must indicate the dominant water tank level at the time of the test and the maximum and minimum operating levels of the tank, as well, or identify applicable water supply fluctuation. The licensed contractor must then design the fire protection system based on this fluctuation information, as per the applicable referenced NFPA standard. Reference Section 903.3.5 for additional design requirements.

Where required. The location, number and type of fire hydrants connected to a water supply capable of delivering the required fire flow shall be provided on the public street or on the site to be protected or both as required by the fire chief. Fire hydrants shall be installed at intervals not to exceed 250 feet (76 200 mm) along new roadways, and at such locations that no part of a building exterior wall is in excess of a hose lay, 300 feet (91 440 mm) in length from the hydrant as measured along an approved route around the exterior of the building.

507.5.4 Obstruction. Unobstructed access to fire hydrants shall be maintained at all times. Posts, fences, vehicles, growth, trash, storage and other materials or objects shall not be placed or kept near fire hydrants, fire department inlet connections or fire protection system control valves in a manner that would prevent such equipment or fire hydrants from being immediately discernible. The fire department shall not be deterred or hindered from gaining immediate access to fire protection equipment or fire hydrants.

507.5.1.1 Hydrant for standpipe systems.

Buildings equipped with a standpipe system installed in accordance with [Section 905](#) shall have a fire hydrant within 100 feet (30 480 mm) of the fire department connections.

Exception: The distance shall be permitted to exceed 100 feet (30 480 mm) where *approved by the fire code official*. from [City of Dallas Ordinance No. 30135](#)

SECTION 604 EMERGENCY AND STANDBY POWER SYSTEMS

604.1.2 Installation. Emergency power systems and standby power systems shall be installed in accordance with the *International Building Code*, NFPA 70, NFPA 110 and NFPA 111. Existing installations shall be maintained in accordance with the original approval, except as specified in Chapter 11.

604.1.9 Critical Operations Power Systems (COPS). For Critical Operations Power Systems necessary to maintain continuous power supply to facilities or parts of facilities that require continuous operation for the reasons of public safety, emergency management, national security, or business continuity, see NFPA 70. Amend Section 604.2 to read as follows:

604.2 Where required. Emergency and standby power systems shall be provided where required by Sections 604.2.1 through 604.2.24 or elsewhere identified in this

code or any other referenced code.

604.2.4 Group A occupancies. Emergency voice/alarm communications systems.

Emergency power shall be provided for emergency voice/alarm communications systems in the following occupancies, or as specified elsewhere in this code, as required in Section 907.5.2.2.5. The system shall be capable of powering the required load for a duration of not less than 24 hours, as required in NFPA 72.

Covered and Open Malls, Section 907.2.20 and 914.2.3
Group A occupancies, Sections 907.2.1 and
907.5.2.2.4. Special Amusement buildings,
Section 907.2.12.3
High-rise buildings, Section 907.2.13
Atriums, Section 907.2.14
Deep Underground buildings, Section 907.2.19

604.2.15 Smoke Control Systems. Standby power shall be provided for smoke control systems in the following occupancies, or as specified elsewhere in this code, as required in Section 909.11:

Covered mall building, *International Building Code*, Section 402.7
Atriums, *International Building Code*, Section 404.7
Underground buildings, *International Building Code*, Section 405.8

Group I-3, *International Building Code*, Section 408.4.2 Stages, *International Building Code*, Section 410.3.7.2

Special Amusement buildings (as applicable to Group A's), *International Building Code*, Section 411.1 Smoke protected seating, Section 1029.6.2.1

604.2.17 covered and open mall buildings. Emergency power shall be provided in accordance with Section 907.2.20 and 914.2.3.

604.2.18 Airport traffic control towers. A standby power system shall be provided in airport traffic control towers more than 65 ft. in height. Power shall be provided to the following equipment:

1. Pressurization equipment, mechanical equipment and lighting.
2. Elevator operating equipment.
3. Fire alarm and smoke detection systems.

604.2.19 enclosures and Stair Pressurization Alternative. Standby power shall be provided for smoke proof enclosures, stair pressurization alternative and associated automatic fire detection systems as required by the *International Building Code*, Section 909.20.6.2.

604.2.20 elevator pressurization. Standby power shall be provided for elevator pressurization system as required by the *International Building Code*, Section 909.21.5.

604.2.21 Shaft Penetrations. Standby power shall be provided when eliminating the smoke dampers in ducts penetrating shafts in accordance with the *International Building Code*, Section 717.5.3, exception 2.3.

604.2.22 st systems for clothes dryers. Standby power shall be provided for common exhaust systems for clothes dryers located in multistory structures in accordance with the *International Mechanical Code*, Section 504.10, Item 7.

604.2.23 hydrogen Cutoff Rooms. Standby power shall be provided for mechanical ventilation and gas detection systems of Hydrogen Cutoff Rooms in accordance with the *International Building Code*, Section 421.8.

604.2.24 means of Egress Illumination in Existing Buildings. Emergency power shall be provided for *means of egress* illumination in accordance with Section 1104.5 when required by the fire code official. (90 minutes in I-2, 60 minutes elsewhere.)

604.8 Energy time duration. Unless a time limit is specified by the fire code official, in this chapter or elsewhere in this code, or in any other referenced code or standard, the emergency and standby power system shall be supplied with enough fuel or energy storage capacity for not less than 2-hour full-demand operation of the system.

Exception: Where the system is supplied with natural gas from a utility provider and is approved.

SECTION 609 COMMERCIAL KITCHEN HOODS

609.2 Where required. A Type I hood shall be installed at or above all commercial cooking appliances and domestic cooking appliances used for commercial purposes that produce grease vapors, including but not limited to cooking equipment used in fixed, mobile, or temporary concessions, such as trucks, buses, trailers, pavilions, or any form of roofed enclosure, as required by the fire code official.

SECTION 704 FLOOR OPENINGS AND SHAFTS

704.1 Enclosure. Interior vertical shafts including, but not limited to, *stairways*, elevator hoist ways, service and utility shafts, that connect two or more stories of a building shall be enclosed or protected in accordance with the codes in effect at the time of construction but, regardless of when constructed, not less than as required in Chapter 11. New floor openings in existing buildings shall comply with the *International Building Code*.

SECTION 901 GENERAL

901.6.1.1 Standpipe Testing. Building owners/managers must maintain and test standpipe systems as per NFPA 25 requirements. The following additional requirements shall be applied to the testing that is required every 5 years:

1. The piping between the Fire Department Connection (FDC) and the standpipe shall be back flushed when foreign material is present, and also hydrostatically tested for all FDC's on any type of standpipe system. Hydrostatic testing shall also be conducted in accordance with NFPA 25 requirements for the different types of standpipe systems.
2. For any manual (dry or wet) standpipe system not having an automatic water supply capable of flowing water through the standpipe, the tester shall connect hose from a fire hydrant or portable pumping system (as approved by the *fire code official*) to each FDC, and flow water through the standpipe system to the roof outlet to verify that each inlet connection functions properly. Confirm that there are no open hose valves prior to introducing water into a dry standpipe. There is no required pressure criteria at the outlet. Verify that check valves function properly and that there are no closed control valves on the system.
3. Any pressure relief, reducing, or control valves shall be tested in accordance with the requirements of NFPA 25. All hose valves shall be exercised.
4. If the FDC is not already provided with approved caps, the contractor shall install such caps for all FDC's as required by the *fire code official*.
5. Upon successful completion of standpipe test, place a blue tag (as per Texas Administrative Code, Fire Sprinkler Rules for Inspection, Test and Maintenance Service (ITM) Tag) at the bottom of each standpipe riser in the building. The tag shall be check-marked as "Fifth Year" for Type of ITM, and the note on the back of the tag shall read "5 Year Standpipe Test" at a minimum.
6. The procedures required by Texas Administrative Code Fire Sprinkler Rules with regard to Yellow Tags and Red Tags or any deficiencies noted during the testing, including the required notification of the local Authority Having Jurisdiction (*fire code official*) shall be followed.

7. Additionally, records of the testing shall be maintained by the owner and contractor, if applicable, as required by the State Rules mentioned above and NFPA 25.

901.6.3 False Alarms and Nuisance Alarms. False alarms and nuisance alarms shall not be given, signaled or transmitted or caused or permitted to be given, signaled for transmitted in any manner.

901.7 Systems out of service. Where a required *fire protection system* is out of service or in the event of an excessive number of activations, the fire department and the *fire code official* shall be notified immediately and, where required by the *fire code official*, the building shall either be evacuated or an *approved fire watch* shall be provided for all occupants left unprotected by the shut down until the *fire protection system* has been returned to service.

SECTION 903 AUTOMATIC SPRINKLER SYSTEMS

903.2.11.3 Buildings more than 55 feet in height. An *automatic sprinkler system* shall be installed throughout buildings that have one or more stories with an occupant load of 30 or more, other than penthouses in compliance with Section 1509 of the Building Code, that is located more than 55 feet (16 764 mm) or more above the lowest level of fire department vehicle access measured to the finished floor.

Exception:

Open parking structures in compliance with Section 406.5 of the International Building Code, having no other occupancies above the subject garage.

903.2.11.7 High-piled combustible storage. For any building with a clear height exceeding 12 feet (4572 mm), see Chapter 32 to determine if those provisions apply.

903.2.11.8 Buildings with a floor area exceeding 4,000 square feet. An automatic sprinkler system shall be installed throughout all buildings with a building area exceeding 4,000 square feet. For the purpose of this provision, fire walls shall not define separate buildings.

Exception:

Open parking garages.

903.2.11.9 Self-service storage facilities. An approved automatic sprinkler system shall be installed throughout all self-storage facilities.

903.3.1.1.1 Exempt locations. When approved by the *fire code official*, automatic sprinklers shall not be required in the following rooms or areas where it is damp, of fire-resistance-rated construction or contains electrical equipment.

1. Any room where the application of water, or flame and water, constitutes a serious life or fire hazard.
2. Any room or space where sprinklers are considered undesirable because of the nature of the contents, when approved by the code official.
3. Generator and transformer rooms, under the direct control of a public utility, separated from the remainder of the building by walls and floor/ceiling or roof/ceiling assemblies having a fire- resistance rating of not less than 2 hours.
4. Elevator machine rooms, machinery spaces, and hoist ways, other than pits where such sprinklers would not necessitate shunt trip requirements under any circumstances.

SECTION 905 STANDPIPE SYSTEMS

905.3.9 Buildings exceeding 10,000 sq. ft. In buildings exceeding 10,000 square feet in area per story and where any portion of the building's interior area is more than 200 feet (60960 mm) of travel, vertically and horizontally, from the nearest point of fire department vehicle access, Class I automatic wet or manual wet standpipes shall be provided.

Exceptions:

1. Automatic dry and semi-automatic dry standpipes are allowed as provided for in NFPA 14.
2. R-2 occupancies of four stories or less in height having no interior corridors.

905.4 Location of Class I standpipe hose connections. Class I standpipe hose connections shall be provided in all of the following locations:

1. In every required exit stairway, a hose connection shall be provided for each story above and below grade plane. Hose connections shall be located at an intermediate landing between stories, unless otherwise approved by the fire code official.
2. {No Change}
3. In every exit passageway, at the entrance from the exit passageway to other areas of a building.

Exception: Where floor areas adjacent to an exit passageway are reachable from an exit stairway hose connection by a 30-foot (9144 mm) hose stream from a nozzle attached to 100 feet (30 480 mm) of hose, a hose connection shall not be required at the horizontal exit.

4. {No Change}
5. Where the roof has a slope less than four units vertical in 12 units horizontal (33.3-percent slope), each standpipe shall be provided with a two-way a hose connection shall be located to serve the roof or at the highest landing of an exit

stairway with stair access to the roof provided in accordance with Section 1011.12.

6. When required by this Chapter, standpipe connections shall be placed adjacent to all required exits to the structure and at two hundred feet (200') intervals along major corridors thereafter, or as otherwise approved

SECTION 907 FIRE ALARM AND DETECTION SYSTEMS

All buildings or occupancies, occupied, operated, maintained or monitored by the Dallas-Fort Worth International Airport Board shall have a complete operational manual and automatic fire alarm system in accordance with this code. The system shall be designed and installed in accordance with the DFW Airport Design Criteria Manual and applicable standards.

All buildings, other than those described in the preceding paragraph, hereafter constructed or moved on to the airport and having a total floor area of 1,000 square feet or more, regardless of height or occupant load, shall have a complete operational manual and automatic fire alarm system in accordance with the occupancy requirements of this code.

Exceptions:

1. Open parking garages may use other approved means for fire department notification.
2. Temporary structures or buildings erected for less than 365 days when approved by the AHJ.

907.2.13 High-rise buildings. Buildings having floors used for human occupancy located more than 55 feet (16 764 mm) above the lowest level of fire department vehicle access shall be provided with an automatic smoke detection system in accordance with Section 907.2.13.1, a fire department communication system in accordance with Section 907.2.13.2 and an emergency voice/alarm communication system in accordance with Section 907.6.2.2.

907.4.2 Manual fire alarm boxes. Where a Manual fire alarm system is required by another section of this code, it shall be activated by fire alarm boxes installed in accordance with sections 907.4.2.1 through 907.4.2.6. Manual alarm actuating devices shall be of an approved double action type.

907.5

Exceptions:

1. Where approved by the code official in airport terminal buildings, and where the fire alarm is monitored directly by the Dallas/Fort Worth International Airport Board, Department of Public Safety, the activation of

the fire alarm notification signal shall be manually initiated by emergency responders.

SECTION 910 SMOKE AND HEAT REMOVAL

901.2.3 Group H. Buildings and portions thereof used as a Group H occupancy as follows:

1. In occupancies classified as Group H-2 or H-3, any of which are more than 15,000 square feet (1394 sqm) in single floor area.

Exception: Buildings of noncombustible construction containing only noncombustible materials.

2. In areas of buildings in Group H used for storing Class 2, 3 and 4 liquid and solid oxidizers, Class 1 and unclassified detonable organic peroxides, Class 3 and 4 unstable (reactive) materials, or Class 2 or 3 water-reactive materials as required for a high-hazard commodity classification.

Exception: Buildings of noncombustible construction containing only noncombustible materials.

913.2.1 When located on the ground level at an exterior wall, the fire pump room shall be provided with an exterior fire department access door that is not less than 3 ft. in width and 6 ft. – 8 in. in height, regardless of any interior doors that are provided. A key box shall be provided at this door, as required by Section 506.1.

Exception: When it is necessary to locate the fire pump room on other levels for not at an exterior wall, the corridor leading to the fire pump room access from the exterior of the building shall be provided with equivalent fire resistance as that required for the pump room, or as approved by the *fire code official*. Access keys shall be provided in the key box as required by Section 506.1.

SECTION 1003 GENERAL MEANS OF EGRESS

1003.5

Exception: 4. At entrances to mechanical penthouses from roofed areas, the door sill elevation may be up to 8 inches (203 mm) above the elevation of the landing on either or both sides of the door.

SECTION 1004 OCCUPANT LOAD

[B] 1004.3 Posting of occupant load. Every room or space that is an assembly occupancy shall have the occupant load of the room or space posted in a conspicuous place, near the main exit or exit access doorway from the room or space. Posted signs

shall be of an approved legible permanent design and shall be maintained by the owner or authorized agent. Assembly occupancies within airport terminal buildings are not required to have the occupant load posted unless required by the Building Official.

SECTION 1023 INTERIOR EXIT STAIRWAYS AND RAMPS

1023.11 Smokeproof enclosures. In buildings required to comply with Section 403 or 405 of the International Building Code, each of the exit enclosures serving a story with a floor surface located more than 55 feet (16 764 mm) above the lowest level of fire department vehicle access or more than 30 feet (9144 mm) below the finished floor of a level of exit discharge serving such stories shall be a smoke proof enclosure or pressurized stairway in accordance with Section 909.20 of the International Building Code.

Exception:

Fixed guideway train stations.

SECTION 5005 USE, DISPENSING AND HANDLING

5005.1.8 Gas cabinets, exhaust enclosures and exhaust ducts with a cross sectional dimension of 10 inches (255 mm) or greater shall be internally sprinklered.

SECTION 5704 STORAGE

5704.2.9.5.3 Combustible liquid storage tanks inside of buildings. The maximum aggregate allowable quantity limit shall be 3,000 gallons (11 356 L) of Class II or III combustible liquid for storage in protected aboveground tanks complying with Section when all of the following conditions are met:

1. The entire 3,000 gallon (11 356 L) quantity shall be stored in protected above-ground tanks;
2. The 3,000 gallon (11 356 L) capacity shall be permitted to be stored in a single tank or multiple smaller tanks;
3. The tanks shall be located in a room protected by an *automatic sprinkler system* complying with Section 903.3.1.1; and
4. Tanks shall be connected to fuel-burning equipment, including generators, utilizing an *approved* closed piping system.

The quantity of combustible liquid stored in tanks complying with this section shall not be counted towards the maximum allowable quantity set forth in Table 5003.1.1(1), and

such tanks shall not be required to be located in a control area. Such tanks shall not be located more than two stories below grade.

**SECTION 5706
SPECIAL OPERATIONS**

5706.3.1.3.3 Natural gas pipeline setback from buildings. No building hereinafter erected shall be located within 50 feet (15 240 mm) of a natural gas gathering pipeline.

**SECTION 6003
HIGHLY TOXIC AND TOXIC SOLIDS AND LIQUIDS**

6003.5

Exception:

Sprinklers are not required for certain water reactive materials when sprinklers would not be effective in controlling the fire.

**CHAPTER 80 REFERENCED
STANDARDS**

Standard Reference Number 130-2014 – NFPA 130, Standard for Fixed Guideway Transit and Passenger Rail Systems

ADOPTION OF APPENDIX CHAPTERS

The following appendix chapters are specifically adopted as part of the Fire Code.

- | | |
|-------------------|---|
| Appendix B | Fire Flow Requirements for Buildings (Except B105.3 – Water supply for buildings equipped with an automatic sprinkler system) |
| Appendix C | Fire Hydrant Locations and Distribution (Except hydrant spacing as required by Section 507.5.1.) |
| Appendix D | Fire Apparatus Access Roads (except that minimum width of fire apparatus access roads shall be in accordance with Section 503.2.1 of the Fire Code) |
| Appendix G | Cryogenic Fluids – Weight and Volume Equivalents |
| Appendix L | Requirements for Fire Fighter Air Replenishment System |

PART FOUR – ELECTRICAL CODE AMENDMENTS

ARTICLE 89

TITLE

~~**89.1 Title.** The 2014 National Electrical Code (NFPA 70) as amended herein is the Electrical Code of Dallas-Fort Worth International Airport.~~

~~**89.2 Creation of enforcement agency.** The department of electrical inspection is hereby created and the official in charge thereof shall be known as the building official. The function of the department shall be to assist the building official in the administration and enforcement of the provisions of this code. References to the department of electrical inspection shall mean the Code Compliance Section of the Design, Code & Construction Department.~~

~~**89.3 Schedule of permit fees.** Refer to Part Two, Building Code Amendments, Section 109 for fees.~~

~~**89.4 Penalties.** Refer to Part One, Construction and Fire Prevention Standards Resolution, Section 27, Penal Clause.~~

~~**89.5 Means of Appeal.** Refer to Part One, Construction and Fire Prevention Standards Resolution for Board of Appeals.~~

89.6 Energized Electrical. All electrical energy which requires an electrical inspection by the DFW Building Official or their representatives, shall first receive an approved inspection prior to energizing the equipment and/ or the conductors. Electrical equipment energized without an approved inspection shall be deemed unsafe electrical.

89.7 Approval. The conductors and equipment required or permitted by this Code shall be acceptable only if approved. Approval of equipment may be evident by listing and labeling of equipment by a Nationally Recognized Testing Lab (NRTL) with a certification mark of that laboratory or a qualified third party inspection agency approved by the AHJ.

PART FIVE - MECHANICAL CODE AMENDMENTS

SECTION 101 GENERAL

101.1 Title. The 2021 International Mechanical Code as amended herein is the Mechanical Code of Dallas-Fort Worth International Airport. References to the International Mechanical Code shall be construed to reference the Mechanical Code as adopted herein with its local amendments.

502.4 Stationary Storage Battery Systems

Stationary storage battery systems shall be regulated and ventilated in accordance with [Section 1207.6.1 of the International Fire Code](#) “Added to DFW Code”:the amendments below and the other general requirements of this chapter.

Ventilation Based on Exhaust Rate

Mechanical exhaust ventilation shall be provided at a rate of not less than 1 ft³/min/ft² (5.1 L/sec/m²) of floor area of the room, area or walk-in unit. The ventilation shall be either continuous or shall be activated by a gas detection system.

Standby Power

Mechanical exhaust ventilation shall be provided with a minimum of 2 hours of standby power.

Commercial kitchen exhaust hood systems

Shall operate during the cooking operation. The hood exhaust rate shall comply with the listing of the hood or shall comply with Section 507.5. The exhaust fan serving a Type I hood shall have automatic controls that will activate the fan when any appliance that requires such Type I hood is turned on, or a means of interlock shall be provided that will prevent operation of such appliances when the exhaust fan is not turned on. Where one or more temperature or radiant energy sensors are used to activate a Type I hood exhaust fan, the fan shall activate not more than 15 minutes after the first appliance served by that hood has been turned on. A method of interlock between an exhaust hood system and appliances equipped with standing pilot burners shall not cause the pilot burners to be extinguished. A method of interlock between an exhaust hood system and cooking appliances shall not involve or depend on any component of a fire-extinguishing system. Airflow sensors shall continuously monitor air flow optimizing performance and grease removal while an interlocking system will not allow cooking appliances to function if filters are missing, clogged, or in the event of a fire.

**SECTION 103
DEPARTMENT OF MECHANICAL INSPECTION**

103.1 General. The department of mechanical inspection is hereby created and the executive official in charge thereof shall be known as the building official. References to the department of mechanical inspection shall mean the Code Compliance Section of the Design, Code & Construction.

**SECTION 106
PERMITS**

106.5.2 Fee schedule. Refer to Part Two, Building Code Amendments, Section 109 for fees.

106.5.3 Fee refunds. The building official is authorized to establish a refund policy.

**SECTION 108
VIOLATIONS**

108.4 Violation penalties. Refer to Part One, Construction and Fire Prevention Standards Resolution, Section 27, Penal Clause.

**SECTION 109
MEANS OF APPEAL**

Replace Section 109 with the following reference:

Refer to Part One, Construction and Fire Prevention Standards Resolution for Board of Appeals.

PART SIX - PLUMBING CODE AMENDMENTS

SECTION 101 GENERAL

101.1 Title. The 2021 International Plumbing Code as amended herein is the Plumbing Code of Dallas-Fort Worth International Airport. References to the International Plumbing Code shall be construed to reference the Plumbing Code as adopted herein with its local amendments.

HANGERS. See "Supports": shall be installed with all thread rods and clevis hangers, Unistrut with pipe clamps, pipe titans or an approved equal.

Risers. See "water pipe, riser". Cleanouts shall be required above the floor on risers or vents for at all lavatories, sinks, urinals, mop sinks, roof drains, automatic clothes washers, and drinking fountains.

307.3 Penetrations of Floor/Ceiling Assemblies and Fire-Resistance-Rated Assemblies

Penetrations of floor/ceiling assemblies and assemblies required to have a fire-resistance rating shall be protected in accordance with the *International Building Code*. PVC larger than 2" which penetrates through a 2-hour fire rated upper floor shall be equipped with 2-hour intumescent fire protection coupling.

606.1 Location of Full-Open Valves

6. On the entrance to every water supply pipe to a dwelling unit. ~~except where supplying a single-fixture equipped with individual stops.~~

608.4 Potable Water Handling and Treatment Equipment

Added to DFW Code": An RPZ shall be installed prior to Water pumps, filters, softeners, tanks and other appliances and devices that handle or treat potable water to be supplied to the potable water distribution system shall be located to prevent contamination from entering the appliances and devices. Overflow, relief valve and waste discharge pipes from such appliances and devices shall terminate through an air gap.

708.1 Cleanouts Required

Cleanouts shall be provided for drainage piping in accordance with Sections 708.1.1 through 708.1.12. All main building drains and branch drains below the floor shall either be wall cleanouts above the floor or floor cleanouts.

717.3 Pre-Installation Inspection

The existing piping sections to be replaced or connected to shall be inspected internally by

a recorded video camera survey. The survey shall include notations of the position of cleanouts and the depth of connections to the existing piping.

Post Installation Inspection

The building drain and building sewer shall be inspected internally by a recorded video camera survey. A copy of the video will be provided to the building official prior to concrete being installed.

915.2.3 Connection

The combination waste and vent system shall be provided with a dry vent connected at any point within the system or the system shall connect to a horizontal drain that serves vented fixtures located on the same floor. Combination waste and vent systems connecting to building drains receiving only the discharge from one or more stacks shall be provided with a dry vent. The area of a vent installed in a combination waste and vent system shall be not less than one pipe size smaller than the drain pipe served. The vent connection to the combination waste and vent pipe shall extend vertically to a point not less than 6 inches (152 mm) above the flood level rim of the highest fixture being vented before offsetting horizontally. P-Traps for a combination waste and vent system shall reduce at the main or the trap inlet, one pipe size.

1003.3.1 Grease Interceptors and Automatic Grease Removal Devices Required

A grease interceptor or automatic grease removal device shall be required to receive the drainage from fixtures and equipment with grease laden waste located in food preparation areas, such as in restaurants, hotel kitchens, hospitals, school kitchens, bars, factory cafeterias and clubs. Additionally, floor drains which are located by trash compactors or any other piece of equipment, or devices where wash down stations are located to rinse grease laden products shall require a grease interceptor. Fixtures and equipment shall include pot sinks, prerinse sinks; soup kettles or similar devices; work stations; floor drains or sinks into which kettles are drained; automatic hood wash units and dishwashers without prerinse sinks. Grease interceptors and automatic grease removal devices shall receive waste only from fixtures and equipment that allow fats, oils or grease to be discharged. Where lack of space or other constraints prevent the installation or replacement of a grease interceptor, one or more grease interceptors shall be permitted to be installed on or above the floor and upstream of an existing grease interceptor .

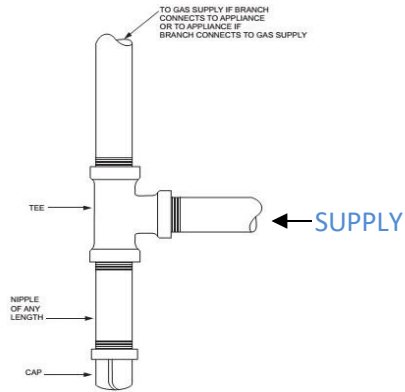

FIGURE 408.4 METHOD OF INSTALLING A TEE FITTING SEDIMENT TRAP

SECTION 103 DEPARTMENT OF PLUMBING INSPECTION

103.1 General. The department of Plumbing inspection is hereby created and the executive official in charge thereof shall be known as the building official. References to the department of plumbing inspection shall mean the Code Compliance Section of the Design, Code & Construction Department.

SECTION 106 PERMITS

106.6.2 Fee schedule. Refer to Part Two, Building Code Amendments, Section 109 for fees.

106.6.3 Fee refunds. The building official is authorized to establish a refund policy.

SECTION 108 VIOLATIONS

108.4 Violation penalties. Refer to Part One, Construction and Fire Prevention Standards Resolution, Section 27, Penal Clause.

SECTION 109 MEANS OF APPEAL

Refer to Part One, Construction and Fire Prevention Standards Resolution for Board of Appeals.

**SECTION 312
TESTS AND INSPECTIONS**

312.10 Inspection and testing of backflow prevention assemblies. Backflow prevention assemblies shall be inspected and tested as required by Texas Administrative Code, Title 30, Part 1, Chapter 290 Public Drinking Water.

**TABLE 403.1
MINIMUM NUMBER OF REQUIRED PLUMBING FACILITIES**

OCCUPANCY	WATER CLOSETS (Urinals see Section 419.2)		LAVATORIES	BATHTUBS/ SHOWERS	DRINKING FOUNTAINS (See Section 410.1)	OTHERS
	Male	Female				
Public assembly areas of passenger terminals and transportation facilities	1 per 100	1 per 100	1 per 200	---	1 per 1,000	1 service sink

**SECTION 404
ACCESSIBLE PLUMBING FACILITIES**

Refer to Part Two, Building Code Amendments, Chapter 11 for accessibility standards.

**SECTION 1106
SIZES OF CONDUCTORS, LEADERS AND STORM DRAINS**

1106.1 General. The size of the vertical conductors and leaders, building storm drains, building storm sewers and any horizontal branches of such drains or sewers shall be based on 5 inches per hour rainfall rate.

**SECTION 1109
COMBINED SANITARY AND STORM SYSTEM**

1109 Combined sanitary and storm sewer systems shall be prohibited within the airport.

PART SEVEN - FUEL GAS CODE AMENDMENTS

SECTION 101 GENERAL

101.1 Title. The 2021 International Fuel Gas Code as amended herein is the Fuel Gas Code of Dallas-Fort Worth International Airport. References to the International Fuel Gas Code shall be construed to reference the Fuel Gas Code as adopted herein with its local amendments.

SECTION 103 DEPARTMENT OF INSPECTION

103.1 General. The Department of Inspection is hereby created and the executive official in charge thereof shall be known as the building official. References to the department of inspection shall mean the Code Compliance Section of the Design, Code & Construction Department.

SECTION 106 PERMITS

106.5.2 Fee schedule. Refer to Part Two, Building Code Amendments, Section 109 for fees.

106.5.3 Fee refunds. The building official is authorized to establish a refund policy.

SECTION 108 VIOLATIONS

108.4 Violation penalties. Refer to Part One, Construction and Fire Prevention Standards Resolution, Section 27, Penal Clause.

**SECTION 109
MEANS OF APPEAL**

Refer to Part One, Construction and Fire Prevention Standards Resolution for Board of Appeals.

**SECTION 202 (IFGC)
GENERAL DEFINITIONS**

BUTT WELD JOINT. A welded pipe joint made with the ends of the two pipes butting each other.

SOCKET WELD JOINT. A pipe attachment in which a pipe is inserted into a recessed area of a valve, fitting or flange, generally for small bore piping.

**SECTION 403
PIPING MATERIALS**

403.10.1.1 All fuel gas piping 2 ½ inches and above shall be butt welded. All fuel gas piping 2 inches to ½ inches shall be socket weld. All pipe and fittings shall comply with ASME B 36.10, 10M.

PART EIGHT - ENERGY CODE AMENDMENTS

SECTION C101 SCOPE AND GENERAL REQUIREMENTS

C101.1 Title. The 2021 International Energy Conservation Code as amended herein is the Energy Code of Dallas-Fort Worth International Airport. References to the International Energy Conservation Code shall be construed to reference the Energy Code as adopted herein with its local amendments.

C101.1.1 General. The building official is hereby authorized and directed to enforce the provisions of this code. The building official shall have the authority to render interpretations of this code and to adopt policies and procedures in order to clarify the application of its provisions. Such interpretations, policies and procedures shall be in compliance with the intent and purpose of this code.

SECTION C110 VIOLATION PENALTIES

C110&C110.1 Violation penalties. Refer to Part One, Construction and Fire Prevention Standards Resolution, Section 27, Penal Clause.

SECTION 202 GENERAL DEFINITIONS

CODE OFFICIAL. The building official is charged with the administration and enforcement of this code.

PART NINE – OIL AND GAS EXPLORATION AND PRODUCTION

SECTION 1 GENERAL INFORMATION

The Exploration, development and Production of Gas on the Airport property are activities which make necessary regulations to establish uniform limitations, safeguards and requirements for operations related to the Exploration, Drilling, developing, producing, transporting and storing of Gas and other substances produced in association with Gas within the Airport to protect the health, safety and general welfare of the public, minimize the potential impact to property, protect the quality of the environment and encourage the orderly production of available mineral, and gas resources.

SECTION 2 DEFINITIONS

The following words, terms and phrases, when used in this Part, shall have the meanings ascribed to them in this section:

Abandonment: means “abandonment” as defined by the Commission and includes the plugging of a Well and the restoration of the area used during the Production of a Well as required by this Part.

All-Weather Hard Surface: means a permanent surface that as a minimum is a base course constructed such that it meets the requirements of the Fire Code, is at least twenty two feet (22’) wide, has an overhead clearance of fourteen feet (14’), drains appropriately, remains water resistant, is free of litter, debris, weeds, grass or other objectionable materials or objects and is visibly dust free.

API: means the American Petroleum Institute.

Berm: means a mound of soil, either natural or manmade, used to obstruct a view. The side slope shall not exceed a three-foot (3’) horizontal and a one-foot (1’) vertical slope.

Blowout Preventer: means a mechanical, hydraulic, pneumatic or other device or combination of such devices, including valves, fittings and control mechanisms connected therewith, which can be closed around the drill pipe, or other tubular goods which completely close the top of the casing and are designed for preventing blowouts.

Brackish Water: means flow back water used in the fracturing and re-fracturing process and other waste liquids produced in association with the production, treatment, processing or transportation of hydrocarbons.

Building: means any structure used or intended for supporting or sheltering any use or occupancy. Buildings with an occupant load of 3 or fewer in accordance with Table 1004.1.1 of the Building Code are not subject to the setback requirements of this Part.

Building Code: as defined in Part Two.

Building Official: as defined in Section 5, Part 1.

Closed Loop System: means a system utilized while drilling so that the reserve pits are not used and instead steel bins are used to collect all drilling waste.

Commission: means the Texas Railroad Commission and all state rules.

Completion: means the earlier of the date the work is completed for the Drilling, re-drilling or reworking of a Well and the crew involved in such activities is released or the date the rig is released.

Compliant well: means a well that is actively producing, actively used for injection or disposal, or has a valid Statewide Rule 14(b)(2) plugging extension.

Derrick: means any portable framework, tower, mast and/or structure, which is required or used in connection with Drilling or re-working a Well for the production of Gas.

Disposal Well: means a well drilled for the purpose of disposing of Brackish Water.

Drilling: means digging or boring a new Well for the purpose of exploring for, developing or producing Gas or for the purpose of injecting Gas, water or any other fluid or substance into the earth.

Drill Site: means the immediate area used during the Drilling, re-drilling or re-working of a Well.

Electrical Code: as defined in Part Four.

Emergency Response Plan: means a plan put in place to deal with emergency situations that may occur at the Drill Site and/or the Operation Site.

Energy Code: as defined in Part Eight.

Exploration: means geologic or geophysical activities, including seismic surveys, related to the search for Gas or other subsurface hydrocarbons.

FEMA: means the Federal Emergency Management Agency.

FIRM: means the Flood Insurance Rate Map.

Fire Chief: as defined in Section 5, Part 1

Fire Code: as defined in Part Three.

Fire Department: means the Fire Department of the Airport.

Frac Tank: means an enclosed steel tank used to hold Brackish Water.

Fracturing: means the injecting of a substance into a Well or formation so as to cause underground channels in hydro-carbon-bearing formations to open.

Fresh Water Fracing Pit: means a pond open to the atmosphere, used to hold fresh water for Fracturing.

Fuel Gas Code: as defined in Part Seven.

Gas: means any fluid, either combustible or noncombustible, which is produced in a natural state from the earth and which maintains a gaseous or rarefied state at standard temperature and pressure conditions and/or the gaseous components or vapors occurring in or derived from petroleum or Gas.

Gas Well: means any Well drilled, to be drilled, or used for the intended or actual production of natural gas.

Inactive well: means a well that is compliant or noncompliant well that is not actively producing, injecting, or disposing.

Mechanical Code: as defined in Part Five.

Non-compliant well: means a well that has been shut-in for a period in excess of twelve (12) months, has not been plugged, and does not have a valid Statewide Rule 14(b)(2) extension.

Oil: means crude petroleum oil and other hydrocarbons regardless of gravity which are produced at the wellhead in liquid form and the liquid hydrocarbons known as distillate or condensate recovered or extracted from Gas, other than gas produced in association with oil and commonly known as casing head gas.

Oil Well: means any Well drilled, to be drilled, or used for the intended or actual production of Oil.

Operation Site: means the area used for development and production and all operational activities associated with Gas after Drilling activities are complete.

Operator: means, for each Well, the person listed on the Commission's Form W-1 or Form P-4 for a Gas Well or Oil Well that is, or will be actually in charge and in control of

Drilling, maintaining, operating, pumping or controlling any Well, including, without limitation, a unit operator.

Permit: means any written license granted by the Airport authorizing the Operator to undertake activity on the Airport.

Plumbing Code: as defined in Part Six.

Production: means the period between Completion of Drilling and the Abandonment of the Well.

Re-Drill: means the Drilling of a new Well located in essentially the same place as an earlier Well or the re-completion of an existing well by deepening or sidetrack operations extending more than one hundred fifty feet (150') from the existing Well bore.

Re-working: means re-completion or re-entry of an existing well within the existing bore hole or by deepening or sidetrack operations which do not extend more than one hundred fifty feet (150') from the existing well bore, or replacement of well liners or casings.

Statewide Rule 14(b) (2) extension: A Texas Railroad Commission administratively granted extension of one year to plug a well, if: the well is in compliance with all other laws and Railroad Commission rules; the well and associated facilities are not a pollution hazard; the operator's report is current and active; and the operator has, and upon request, provides evidence of a good faith claim to operate the well.

Street: means any street, highway, sidewalk, alley, or avenue that is open to public use or is in support of Airport operations.

SWPPP: means storm water pollution prevention plan.

TCEQ: means the Texas Commission on Environmental Quality.

USEPA: means the United States Environmental Protection Agency.

Well: means any single hole or bore to any horizon, formation, or strata, for the purpose of producing Gas and/or Oil from the Airport.

SECTION 3 AIRPORT OVERSIGHT

The Building Official is charged with the administration and enforcement of this part. The Building Official and the Fire Chief shall have the authority to enter and inspect any Drill Site or Operation Site to determine compliance with this Resolution and all applicable laws, rules, regulations, standards or directives adopted by the Airport Board

or State. Failure of any person to permit access to the Building Official or Fire Chief shall constitute a violation of this Resolution. Additionally, the Building Official or Fire Chief and other Airport officials shall have the authority to issue any orders or directives required to implement the intent and purpose of this Resolution and its provisions. The Building Official or Fire Chief shall have the authority to request and receive any records, including any records sent to the Commission, logs, reports and the like, relating to the status or condition of any Well necessary to establish and determine compliance with a Permit. Failure of any person to provide any such requested material shall be deemed a violation of this Resolution.

SECTION 4 OPERATOR'S AGENT

Every Operator shall designate an agent, who is a resident of the State of Texas, upon whom all orders and notices provided in this Resolution may be served in person or by registered or certified mail. Every Operator designating such agent shall within ten (10) days notify the Building Official in writing of any change in such agent or such mailing address unless operations within the Airport are discontinued. Failure to do so shall be deemed a violation of this Resolution.

SECTION 5 SEISMIC SURVEY PERMIT REQUIREMENTS

A Permit shall be required for all geophysical tests, including but not limited to seismic surveys. All applications for a Permit to conduct geophysical tests, including but not limited to seismic surveys, shall be submitted to the Building Official for approval. No geophysical tests shall begin prior to the issuance of a Permit from the Airport Board. A Permit application shall include, but is not limited to, the following information:

- (a) Operator/applicant name, phone number, fax number, physical address, and e-mail address.
- (b) Detailed mapping of location and extent of the proposed geophysical test.
- (c) Detailed explanation of the survey or testing method to be used.
- (d) Frequency and strength of all radio frequency (RF) signals.
- (e) Under no circumstances may explosive charges, including, but not limited to, the use of dynamite, be used in any way related to the preparation for and/or conducting of a geophysical test.

SECTION 6
GAS WELL AND DISPOSAL WELL PERMIT REQUIREMENTS

- (a) No person acting either for himself or acting as an agent, employee, independent contractor, or servant of any person shall drill any Well or Disposal Well, assist in any way in the site preparation, re-working, Fracturing or operation of any Well or Disposal Well or to conduct any activity related to the production of Gas without first obtaining a Permit issued by the Building Official in accordance with this Resolution. Such activities include, but are not limited to, initial site preparation, re-working, Drilling, operations, construction of rigs, Fresh Water Fracing Pit or tank batteries, Fracturing and pressurizing.
- (b) The Operator must apply for and obtain a Permit for the Drilling of each Well or Disposal Well. The Operator shall neither apply for nor obtain a “blanket” Permit for more than one (1) well. A Disposal Well permit will only be issued for disposal of Brackish Water from oil and gas exploration and production, treatment or transportation of hydrocarbons within the boundaries of Dallas/Fort Worth International Airport property. All Disposal Wells must deposit Brackish Water into the Ellenberger formation. Each new Well or Disposal Well established at the ground surface will be considered a new Well or Disposal Well as applicable.
- (c) An existing Permit shall not constitute authority for the re-entering and Drilling of a Well the subject of Abandonment. An Operator shall obtain a new Permit in accordance with the provisions of this Resolution if the Operator is re-entering and Drilling an abandoned Well.
- (d) When a Permit has been issued to the Operator for the Drilling, re-entering, activating or converting of a Well, such Permit shall constitute sufficient authority for Drilling, operation, production gathering or production maintenance, repair, re-working, testing, plugging and Abandonment of the Well and/or any other activity associated with mineral exploration at an Operation Site. An amended Permit shall be obtained before such Well may be modified for purposes of re-drilling, deepening or converting such Well to a depth or use other than that set forth in the then-current Permit for such Well.
- (e) Any person who intends to re-work a Well using a Drilling rig or to engage in Fracturing a Well after initial Completion shall give written notice to, and receive written approval from, the Building Official. The notice must identify where the activities will be conducted and must describe the activities in detail, including, but not limited to the duration of the activities and the time the activities will be conducted. The notice must also provide the address and twenty-four (24) hour telephone number of the person conducting the activities.
- (f) A Permit shall automatically terminate, unless extended, if Drilling is not commenced within one year from the date of the issuance of the Permit. A Permit may be extended by the Building Official upon written request by the

Operator and proof that the regulatory standards of the requested Permit for such location have not changed.

- (g) Permits required by this Resolution are in addition to and are not in lieu of any permit, which may be required by any other governmental agency.
- (h) No Permit shall be issued for any Well to be drilled within the floodway identified by FEMA on the most current FIRM. Wells proposed in the floodplain outside of the floodway shall comply with the requirements of the Building Official.
- (i) No Permit shall be issued for any Well to be drilled that is not in compliance with this Resolution.
- (j) By acceptance of any Permit issued pursuant to this Resolution, the Operator expressly stipulates and agrees to be bound by and comply with the provisions of this Resolution. The terms of this Resolution shall be deemed to be incorporated in any Permit issued pursuant to this Resolution with the same force and effect as if this Resolution was set forth verbatim in such Permit.
- (k) Operator must provide to the Building Official, a copy of all H-5 and mechanical integrity tests required by the Commission.
- (l) All wells located at DFW Airport must be compliant with Texas Railroad Commission rules. Wells that have not been in operation for a year must be plugged and abandoned in accordance with Railroad Commission Statewide Rule 14(b) (2). This rule requires that plugging operations on each inactive well commence within one year after operations have ceased. Prior to abandonment, wells must be plugged consistent with Railroad Commission rules, with cement in a manner that will not allow movement of fluids into or between Underground Sources of Drinking Water (USDWs).

SECTION 7 PERMIT APPLICATION

- (a) Every application for a Permit issued pursuant to this Resolution shall be on forms required by the Building Official, shall include payment of the construction permit and plan review fees and shall be signed by the Operator, or some person duly authorized to sign on his behalf, and filed with the Building Official. The application shall include the following information:
 - (1) The date of the application and type of Permit requested.
 - (2) Map showing proposed transportation route and road(s) for equipment, chemicals or waste products used or produced under the Permit.
 - (3) Proposed Well name and Well depth.

- (4) Name, telephone number, fax number, physical address of individual designated to receive notice, and, if possible, e-mail address.
- (5) Names and addresses of representatives or Operator's agent with supervisory authority over the Drill Site or Operation Site and a twenty-four (24) hour telephone number.
- (6) Location and description of all improvements and structures within eight hundred feet (800') of the Well. Such locations and descriptions shall be prepared by a Registered Professional Land Surveyor.
- (7) A site plan of the proposed Drill Site and Operation Site showing the location of all improvements and equipment, including the location of the proposed Well and other facilities including, but not limited to, Fresh Water Fracing Pit, Disposal Well, tanks, pipelines, compressors, separators and storage tanks or storage sheds. All site plans must include the following criteria:
 - a. Location of proposed Buildings and structures indicating sizes in square feet.
 - b. The location and intensity of exterior lighting fixtures.
 - c. The location of mechanical equipment.
 - d. Outside storage areas.
 - e. Curb cut locations.
 - f. Parking, loading, and maneuvering areas.
 - g. The location, materials and dimensions of screening improvements as required.
 - h. Waste disposal locations.
 - i. Streets immediately adjacent to the Operation Site.
 - j. Drill Site and Operation Site plans shall be submitted on a sheet size of 24" x 36" minimum, or as approved by the Building Official.
 - k. Airport boundaries where applicable.
 - l. Date the drawing was prepared with name, address, and phone number of preparer.

- m. North arrow, at a maximum scale of 1:50 immediately adjacent to the Drill Site or Operation Site.
 - n. Title Block identifying the Drill Site or Operation Site location.
 - o. Vicinity location map at 1" = 2000'.
 - p. Location of 100-year flood limits where applicable.
 - q. Texas NAD83 State Plane Coordinates for all four corners.
- (8) Copy of all reports and permits required by the Commission, specifically including a copy of the approved Commission Form W-1, H-5 and/or P-4.
 - (9) A description of public utilities required during Drilling and Production.
 - (10) A description of the water source to be used during Drilling.
 - (11) A copy of the Erosion Control Plan as required by the Airport Board.
 - (12) A copy of the determination by the TCEQ of the depth of useable quality ground water.
 - (13) A copy of the TCEQ permit.
 - (14) A statement, under oath, signed by the Operator or designated representative, that the information submitted with the application is, to the best knowledge and belief of the Operator or designated representative, true and correct.
 - (15) Three copies of a Hazardous Material Management Plan and additionally, all material safety data sheets for all hazardous materials that will be located, stored, transported and/or temporarily used on the Drill Site shall be provided to the Building Official.
 - (16) Three copies of the Hazardous Materials Inventory Statement.
 - (17) Operator shall submit to the Building Official, for review and approval, an Emergency Response Plan establishing written procedures to minimize any hazard resulting from Drilling, Completion or producing of a Gas Well. Said plan shall use existing guidelines established by the Commission, TCEQ, Texas Department of Transportation, the Fire Code and/or the USEPA. A copy of the Emergency Response Plan shall be kept on site.
 - (18) A map showing the location of all underground transmission pipelines.

**SECTION 8
PERMITTING PROCEDURE**

- (a) All Well Permit applications will be filed through the Building Official.
- (b) It is the responsibility of the Building Official to review and approve or disapprove all applications for Permits based on the criteria established by this Resolution.
- (c) After the filing of a completed application, payment of permit and plan review fees and remittance of all insurance and security per the requirements of this Resolution for a Permit, the Building Official will determine whether the Permit application shall be approved or denied.
- (d) The provisions of this Resolution shall apply to any application for a Permit that is filed with the Building Official.
- (e) If all the requirements of this Resolution are met, the Building Official shall issue a Permit for the activity for which the Permit application was made.
- (f) If the Building Official denies a Permit application, the Building Official shall notify the Operator in writing of such denial stating the reasons for the denial. The Operator may cure those conditions that caused the denial and resubmit the application to the Building Official for approval and issuance of the Permit.

**SECTION 9
AMENDED GAS WELL PERMITS**

- (a) An amended Permit may be issued for, but not limited to, the following changes in Drill Site or Operation Site activities:
 - (1) Re-drilling;
 - (2) Deepening beyond one hundred fifty feet (150') of the permitted depth;
 - (3) Site access; and
 - (4) Locations and/or quantities of equipment as determined by the Building Official;
- (b) Applications for amended Permits shall be in writing, shall be signed by the Operator, and shall include the following:
 - (1) A description of the proposed amendments;

- (2) Any changes to the information submitted with the application for the existing Permit (if such information has not previously been provided to the Airport Board);
 - (3) Such additional information as is reasonably required by the Building Official to demonstrate compliance with the Permit;
 - (4) Such additional information as is reasonably required by the Building Official to prevent imminent destruction of property or injury to persons; and
 - (5) An amended site plan and plat indicating the new bottom-hole location.
- (c) All applications for amended Permits shall be filed with the Building Official for review. Incomplete applications may be returned to the applicant, in which case the Building Official shall provide a written explanation of the deficiencies.
- (d) If the activities proposed by the amendment are not materially different from the activities covered by the existing Permit then the Building Official shall approve or disapprove the amendment after the application is filed.
- (e) If the activities proposed by the amendment are materially different from the activities covered by the existing Permit, and do not create a risk of destruction of property or injury to persons, then the Building Official shall approve or disapprove the amendment. If, however, the activities proposed by the amendment are materially different and, in the judgment of the Building Official might create a risk of destruction of property or injury to persons that were not associated with the activities covered by the existing Permit or that were not otherwise taken into consideration by the existing Permit, the Building Official may require the amendment to be processed as a new Permit application.

SECTION 10 SUSPENSION OR REVOCATION OF WELL PERMITS

- (a) If an Operator (or its officers, employees, agents, contractors, or representatives) fails to comply with any requirement of a Permit (including any requirement incorporated by reference as part of the Permit), the Airport Board shall give written notice to the Operator specifying the nature of the failure and giving the Operator a reasonable time to cure, taking into consideration the nature and extent of the failure, the extent of the efforts required to cure, and the potential impact on the health, safety, and welfare of the public. In no event, however, shall the cure period be less than ten (10) days unless the failure presents a risk of imminent danger to property or injury to persons or unless the failure involves the Operator's failure to provide periodic reports as required by this Resolution.
- (b) If the Operator fails to correct the noncompliance, the Airport Board may suspend or revoke the Permit pursuant to the provisions of this Resolution.

- (c) No person shall carry on any operations performed under the terms of a Permit issued under this Resolution during any period of any suspension or revocation of the Permit or pending a review of the decision or order of the Airport Board in suspending or revoking the Permit. Nothing contained herein shall be construed to prevent the necessary, diligent and bona fide efforts to cure and remedy the default or violation for which the suspension or revocation of the Permit was ordered for the safety of persons or as required by the Building Official or the Fire Chief.
- (d) If the Operator does not cure the noncompliance within the time specified in this Resolution, the Airport Board, upon written notice to the Operator, may notify the Commission and request that the Commission take any appropriate action.

SECTION 11 PERIODIC REPORTS

- (a) The Operator shall notify the Building Official of any changes to the following information within ten (10) days after the change occurs:
 - (1) The name, physical address, telephone number, and fax number of the Operator;
 - (2) The name, address, and telephone number of the person designated to receive notices from the Airport Board (which person must be a resident of Texas that can be served in person or by registered or certified mail); and
 - (3) The Operator's emergency action response plan (including "drive-to-maps" from rights-of-way to each Drill Site or Operation Site).
- (b) The Operator shall notify in writing the Building Official of any change to the name, address, and twenty-four (24) hour phone number of the person(s) with supervisory authority over Drilling or operations activities within one (1) business day.
- (c) The Operator shall provide a copy of any "incident reports" or written complaints submitted to the Commission and a copy to the Airport Board within thirty (30) days after the Operator has notice of the existence of such reports or complaints.
- (d) Beginning on December 31st after each Well is completed, and continuing on each December 31st thereafter until the Operator notifies the Building Official that there has been an Abandonment of the Well and the Operation Site is restored, the Operator shall submit a written report to the Building Official identifying any changes to the information that was included in the application for the applicable Permit that have not been previously reported to the Building Official.

SECTION 12
BOND, LETTERS OF CREDIT, INDEMNITY INSURANCE

(a) *General requirements.* The Operator shall be required to:

- (1) Comply with the terms and conditions of this Resolution and the Permit issued hereunder.
- (2) Promptly clear each Drill Site and Operation Site of all litter, trash, waste and other substances used, allowed, or occurring in the operations, and after Abandonment or Completion grade, level and restore such property to the same surface conditions as nearly as possible as existed before operations as determined by the Building Official.
- (3) Promptly pay all fines, penalties and other assessments imposed due to breach of any terms of the Permit.
- (4) Promptly restore to its former condition any property damaged by the Operator.

(b) *Bond, irrevocable letter of credit.* Prior to the issuance of a Permit the Operator shall provide the Building Official with a security instrument in the form of a bond or an irrevocable letter of credit as follows:

- (1) **Bond.** A bond shall be executed by a reliable bonding or insurance institution authorized to do business in Texas, acceptable to the Airport Board. The bond shall become effective on or before the date the Permit is issued and shall remain in force and effect for at least a period of six (6) months after the expiration of the Permit term or until there has been an Abandonment of the Well and the Operation Site is restored, whichever occurs last. The Operator shall be listed as principal and the instrument shall run to the Airport Board, as obligee, and shall be conditioned that the Operator will comply with the terms and regulations of this Resolution and all other laws and regulations. The original bond shall be submitted to the Building Official.
- (2) **Letter of Credit.** A letter of credit shall be issued by a reliable bank authorized to do business in Texas and shall become effective on or before the date the Permit is issued. The letter of credit shall remain in force and effect for at least a period of six (6) months after the expiration of the Permit term or until there has been an Abandonment of the Well and the Drill Site or Operation Site is restored, whichever occurs last. The Airport Board shall be authorized to draw upon such letter of credit to recover any fines, penalties or costs to remedy assessed under this Resolution. Evidence of the execution of a letter of credit shall be submitted to the Building Official by submitting an original signed letter of credit from the banking institution.

- (3) The principal amount of any security instrument shall be fifty thousand dollars (\$50,000) for any single well. After Completion of a Well, the Operator may submit a request to the Building Official to reduce the existing bond to ten thousand dollars (\$10,000) for the remainder of the time the Well produces without reworking. During reworking operations, the amount of the bond or letter of credit shall be maintained at fifty thousand dollars (\$50,000). If at any time after no less than a fifteen (15) day written notice to the Operator, the Airport Board shall deem any Operator's bond or letter of credit to be insufficient, it may require the Operator to increase the amount of the bond or letter of credit up to a maximum of two hundred fifty thousand dollars (\$250,000) per Well.
- (4) Whenever the Building Official finds that a default has occurred in the performance of any requirement or condition imposed by this Resolution, a written notice shall be given to the Operator. Such notice shall specify the work to be done, the estimated cost and the period of time deemed by the Building Official to be reasonably necessary for the completion of such work. After receipt of such notice, the Operator shall, within the time therein specified, either cause or require the work to be performed, or failing to do so, shall pay over to the Airport Board one hundred twenty-five percent (125%) of the estimated cost of doing the work as set forth in the notice. In no event, however, shall the cure period be less than thirty (30) days unless the failure presents a risk of imminent destruction of property or injury to persons or unless the failure involves the Operator's failure to provide periodic reports as required by this Resolution. The Airport Board shall be authorized to draw against any irrevocable letter of credit or bond to recover such amount due from the Operator. Upon receipt of such monies, the Airport Board shall proceed by such mode as deemed convenient to cause the required work to be performed and completed, but no liability shall be incurred other than for the expenditure of said sum in hand. In the event there has not been a proper Abandonment of the Well under the regulations of the Commission, such additional money may be demanded from the Operator as is necessary to properly plug and abandon the Well and restore the Drill Site or Operation Site in conformity with the regulations of this Resolution.
- (5) In the event the Operator does not cause the work to be performed and fails or refuses to pay over to the Airport Board the estimated cost of the work to be done as set forth in the notice, or the issuer of the security instrument refuses to honor any draft by the Airport Board against the applicable irrevocable letter of credit or bond, the Airport Board may proceed to obtain compliance and abate the default by way of civil action against the Operator, or by criminal action against the Operator, or by both such methods.

- (6) When there has been a proper Abandonment of the Well or Wells covered by said irrevocable letters of credit or bond in conformity with all regulations of this Resolution, and in conformity with all regulations of the Commission and notice to that effect has been received by the Airport Board, or upon receipt of a satisfactory substitute, the irrevocable letter of credit or bond issued in compliance with these regulations shall be terminated and cancelled.
- (c) *Insurance.* The Operator must at all times maintain the specific coverages listed below.
- (1) Environmental pollution liability coverage. Operator shall purchase and maintain in force for the duration of the Permit, insurance for environmental pollution liability applicable to bodily injury; property damage, including loss of use of damaged property or of property that has not been physically injured or destroyed; cleanup costs; and defense, including costs and expenses incurred in the investigation, defense or settlement of claims; all in connection with any loss arising from the insured site. Coverage shall be maintained in an amount of at least one million dollars (\$1,000,000) per loss, with an annual aggregate of at least ten million dollars (\$10,000,000).
 - a. Coverage shall apply to sudden and accidental pollution conditions resulting from the escape or release of smoke, vapors, fumes, acids, alkalis, toxic chemicals, liquids or gases, waste material or other irritants, contaminants or pollutants.
 - b. The Operator shall maintain continuous coverage and shall purchase extended coverage period insurance when necessary. The extended coverage period insurance must provide that any retroactive date applicable to coverage under the policy precedes the effective date of the issuance of the Permit by the Building Official.
 - (2) Control of Well. The policy should cover the cost of controlling a Well that is out of control, re-drilling or restoration expenses, seepage and pollution damage as first party recovery for the Operator and related expenses, including, but not limited to, loss of equipment, experts and evacuation of residents, in the amount of five million dollars (\$5,000,000) per occurrence/no aggregate, if available, otherwise an aggregate of ten million dollars (\$10,000,000). Five hundred thousand dollars (\$500,000) sub-limit endorsement may be added for damage to property for which the Operator has care, custody and control.

SECTION 13 SETBACK REQUIREMENTS

The following are minimum setbacks.

- (a) It shall be unlawful to drill, re-drill, deepen, re-enter, activate or convert any Well or Disposal Well, the center of which, at the surface of the ground, is located:
 - (1) Within six hundred feet (600') from any Building; or
 - (2) Within one hundred feet (100') from any Building accessory to, but not necessary to the operation of the well; or
 - (3) Within seventy-five feet (75') of any existing or planned right of way for street, highway or rail; or
 - (4) Within two hundred feet (200') of any existing potable water well.
- (b) Tank batteries, separators and compressors and their associated vents and flares shall be located at least three hundred feet (300') from any Street or Building not used in operations on the Drill Site or Operations Site, nor less than five hundred feet (500') from any flammable bulk storage facility.
- (c) Fresh Water Fracking Pits shall be located at least one hundred feet (100') from any Street or Building.
- (d) The measurement of all distances shall be calculated from the proposed Well bore, Disposal Well bore, tank battery, separator, compressor or Fresh Water Fracking Pit in a straight line, without regard to intervening structures or objects to the closest exterior point of the object listed in items (a) through (c) above. The above calculations shall be prepared by a Registered Professional Land Surveyor.
- (e) As to any public park, residence, religious institution, hospital building, school or other public building that is outside the boundaries of the Airport, the distances set out in subsections (a) through (c) of this section may not be reduced without both of the following:
 - (1) Written notarized waivers granted by all the surface owners must be filed, at the expense of the Operator, in the applicable county records. All waivers must identify the property address, block and lot number, subdivision name and plat volume and page number.
 - (2) With an approved variance obtained in accordance with procedures outlined under Section 20 of this Part.

- (f) As to any Building that is within the boundaries of the Airport, the distances set out in subsections (a) through (c) of this section may be reduced with an approved variance in accordance with procedures outlined under Section 20 of this Part but may not be reduced to less than that permitted by the Fire Code.

SECTION 14 ON SITE AND TECHNICAL REGULATIONS

- (a) Abandoned Wells. All Wells shall be plugged and abandoned in accordance with the rules of the Commission; however, all Well casings shall be cut and removed to a depth of at least three feet (3') below the surface. No Building shall be built over an abandoned well. A well marker, with the well number displayed on it, must be welded to the top of the cut off well pipe.
- (b) Blowout prevention. In all cases, blowout prevention equipment shall be used on all wells being drilled, worked-over or in which tubing is being changed. Protection shall be provided to prevent blowout during petroleum or gas operations as required by and in conformance with the requirements of the Commission and the recommendations of the American Petroleum Institute. The Operator must equip all Drilling Wells with adequate blowout preventers, flow lines and valves commensurate with the working pressures involved as required by the Commission.

The ram-type blowout preventers, valves, and manifolds shall be pressure tested as follows:

- 1.) at the time of installation,
- 2.) whenever any seal subject to test pressure is broken,
- 3.) following related repairs and
- 4.) at 30 day intervals thereafter.

A period of more than thirty (30) days between blowout preventer tests may be allowed, with the Building Official's approval, when well operations prevent testing, provided the tests will be conducted as soon as possible before normal operations resume. The record of communications with the Building Official shall be entered in the driller's log.

During drilling and completion operations, the ram-type blowout preventers shall be tested by closing at least once each trip, and the annular-type preventer shall be tested by closing on drill pipe once each week. All of the above described tests and/or drills shall be recorded in the drilling log and made available to the Building Official upon request.

- (c) Hazardous materials storage. All chemicals and/or hazardous materials shall be stored in such a manner as to prevent, contain, and facilitate rapid remediation and cleanup of any accidental spill, leak, or discharge of a

hazardous material. Operator shall have all material safety data sheets for all hazardous materials on site. All applicable federal and state regulatory requirements for the proper labeling of containers shall be followed. All hazardous materials and/or special hazards at the Well sites shall be protected in accordance with National Fire Protection Association standards, and the Fire Code. Appropriate pollution prevention actions shall be required and include, but are not limited to, chemical and materials raised from the ground (e.g., wooden pallets), bulk storage, installation and maintenance of secondary containment systems, and protection from storm water and weather elements.

- (d) The following requirements shall apply to all Fracturing operations performed on a Well:
 - (1) A watchperson shall be required at all times during such operations; and
 - (2) At no time shall the Well be allowed to flow or vent directly to the atmosphere without first directing the flow through separation equipment or into a portable tank.
- (e) Compliance. Operator shall comply at all times with all applicable federal, state and Airport Board requirements. In the event of any conflicts between the provisions of this Resolution, and the Commission rules and regulations, the more restrictive provision shall apply. Whenever necessary to protect health, safety or welfare, the Building Official or the Fire Chief may direct any Operator to locate, relocate, remove or replace any Well surface facilities located within a particular Operation Site.
- (f) Discharge. No person shall place, deposit, discharge, or cause or permit to be placed, deposited or discharged, any oil, naphtha, petroleum, asphalt, tar, hydrocarbon substances or any refuse including wastewater or brine from any gas operation or the contents of any container used in connection with any gas operation in, into, or upon any Streets, lots, storm drain, ditch or sewer, sanitary drain or any body of water or any property of the Airport.
- (g) Drill stem testing. All open hole formation or drill stem testing shall be done during daylight hours, with adequate advance notification thereof to the Building Official to enable him to be present during such testing. Drill stem tests may be conducted only if the Well effluent during the test is produced through an adequate gas separator to storage tanks and the effluent remaining in the drill pipe at the time the tool is closed is flushed to the surface by circulating drilling fluid down the annulus and up the drill pipe.
- (h) Drip pans and other containment devices. All materials on location (liquids, semi-liquids and solids) and any tanks, containers, pumps, lubricating systems, engines, fuel and chemical storage tanks or systems containing such materials shall be provided with drips pans or other containment devices appropriate to

the risks and hazards that those materials pose to workers, the public and the environment.

- (i) Dust, vibration, odors. All Drilling and production operations shall be conducted in such a manner as to minimize, so far as practicable, dust, vibration, or noxious odors, and shall be in accordance with the best accepted practices incident to Drilling for the production of Gas and other hydrocarbon substances. All equipment used shall be so constructed and operated so that, vibrations, dust, odor or other harmful or annoying substances or effect will be minimized by the operations carried on at any Drilling or production site or from anything incident thereto; nor shall the site or structures thereon be permitted to become dilapidated, unsightly or unsafe. Proven technological improvements as identified by the Building Official in industry standards of Drilling and production in this area may be adopted as they become available if capable of reducing dust, vibration and odor.
- (j) Electric lines. All electric lines to production facilities shall be located in a manner compatible to those already installed in the surrounding area.
- (k) Emergency Response Plan. Prior to the commencement of any Gas or other hydrocarbons site activities, Operator shall submit to the Building Official an Emergency Response Plan establishing written procedures to minimize any hazard resulting from Drilling, Completion or producing of a Gas Well. Said plan shall use existing guidelines established by the Commission, TCEQ, Texas Department of Transportation and/or the USEPA. The Emergency Response Plan shall be kept current with any additions, modifications, and/or amendments concerning all construction-related activities, natural gas operations and, and/or natural gas production. Those updates to the Plan which might materially impact the needs or actions of first responders or the DFW Airport Emergency Management Plan shall be submitted to the approved distribution list as soon as practical. A copy of the Emergency Response Plan shall be kept on site.
- (l) Explosives. Use of explosives within Airport property shall require an Operational Permit issued by the DFW Department of Public Safety Fire Prevention Office. Each use of explosives will be limited to down-hole activities during a single period of time, individual locations and use for jet perforation of wells or other technical applications such as pipe recovery, as described to and approved by the DFW DPS Fire Prevention Office prior to use..
- (m) Fire prevention; sources of ignition. Firefighting apparatus and supplies as approved by the Fire Department and required by any applicable federal, state, local law, or the Fire Code shall be provided by the Operator, at the Operator's cost, and shall be maintained on the Drill Site at all times. The Operator shall be responsible for the maintenance and upkeep of such equipment. At a minimum, the Operator shall provide at each Drill Site at least four portable fire

extinguishers, the size, rating, distribution and maintenance of which shall be in accordance with the National Fire Protection Association Standard #10 and Standard #30. The Fire Department may require more fire extinguishers based on an evaluation of the hazards at the individual sites. Each Well shall be equipped with an automated valve that closes the Well in the event of an abnormal change in operating pressure. All wellheads shall contain an emergency shut off valve to the well distribution line. Lightning protection equipment shall be installed as required at every site in accordance with the National Fire Protection Association Standard 780. Tank battery facilities shall be equipped with a remote foam line and a lightning arrestor system.

- (n) Gas emission or burning restricted. No person shall allow, cause or permit Gas to be vented into the atmosphere or to be burned by open flame except as provided by law or as permitted by the Commission.
- (o) Grass, weeds, trash. Each Drill Site and Operation Site shall be kept clear of high grass, weeds, and combustible trash.
- (p) Lights. No person shall permit any lights located on any Drill Site or Operation Site to be directed in such a manner so that they shine directly on Streets or Buildings. To the extent practicable, and taking into account safety considerations, Drill Site and Operation Site lighting shall be directed downward and shielded so as to both prevent direct illumination of and minimize glare on Streets and Buildings within six hundred feet (600').
- (q) Muffling exhaust. Exhaust from any internal combustion engine, stationary or mounted on wheels, used in connection with the Drilling or for use on any production equipment shall not be discharged into the open air unless it is equipped with an exhaust muffler, or mufflers or an exhaust muffler box constructed of noncombustible materials sufficient to suppress noise and prevent the escape of noxious gases, fumes or ignited carbon or soot. All Fracturing operations shall be conducted during daylight hours unless the Operator has notified the Building Official that Fracturing will occur before or after daylight hours, and the Building Official has approved of such procedures.
- (r) Organic solvents. Organic solvents, such as trichloroethylene and carbon tetrachloride, shall not be used for cleaning any element, structure, or component of the Derrick, drilling rig, platform, and/or associated equipment, tools, or pipes. To the maximum extent practicable, high flash point mineral spirits shall be used.
- (s) Pipe dope for thread protection. Lead-free pipe dope shall be substituted for API specified pipe dope.
- (t) Pits. All Drilling and Wells drilled shall utilize a Closed Loop System. Fresh Water Fracing Pits must be netted at all times to exclude access by waterfowl.

- (u) Private roads and Drill Sites. Prior to the commencement of any Drilling, all roads used for access to the Drill Site and the Operation Site itself shall be at least twenty-two feet (22') wide, have an overhead clearance of fourteen feet (14') and shall be an All-Weather Hard Surface and maintained in accordance with the Fire Code, and to be non-erodible. In particular cases these requirements governing surfacing of roads may be altered at the discretion of the Fire Chief after consideration of all circumstances including, but not limited to, the following: distances from Streets and Buildings; topographical features; nature of the soil; and exposure to wind. All access roads must be kept clean and unobstructed at all times.
- (v) Signs (Refer to Part 2 for sign permitting requirements).
 - (1) A sign shall be immediately and prominently displayed at the gate on the temporary and permanent site fencing erected pursuant to this Resolution. Such sign shall be of durable material, maintained in good condition and, unless otherwise required by the Commission, shall have a surface area of not less than sixteen (16) square feet with contrasting lettering not less than four inches (4") tall and shall be lettered with the following:
 - a. Location Name and Pad Name;
 - b. Name of Operator;
 - c. The emergency 911 number; and
 - d. 24 Hour telephone numbers of two (2) persons responsible for the Well who may be contacted in case of emergency.
 - (2) Permanent weatherproof signs reading "DANGER NO SMOKING ALLOWED" in both English and Spanish shall be posted immediately upon Completion at the Operation Site fencing at the entrance of each Operation Site and tank battery or in any other location approved or designated by the Fire Department. Sign lettering shall be four inches (4") in height and shall be red on a white background or white on a red background. Well and lease designation signage shall be posted in those locations and sizes as required by the Commission in Rule 3.3 Identification of Properties, Wells, and Tanks.
- (w) Storage of equipment. On-site storage is prohibited on the Operation Site. No equipment shall be stored on the Drill Site or Operation Site, unless it is necessary to the everyday operation of the Well. Lumber, pipes, tubing and casing shall not be left on the Operation Site except when Drilling or Well servicing operations are being conducted on the Operation Site. No vehicle or item of machinery shall be parked or stored on any Street, or upon any

Operation Site which constitutes a fire hazard or an obstruction to or interference with fighting or controlling fires except that equipment which is necessary for Drilling or production operations on the Drill Site or Operation Site. The Fire Department shall determine whether equipment constitutes a fire hazard.

- (x) Storage tanks. All tanks intended to contain hydrocarbons and permanent structures shall conform to the API specifications unless other or additional specifications are approved by the Fire Department. All tanks shall require a Fire Code permit and application must be made in accordance with the Fire Code. All storage tanks shall be equipped with a secondary containment system including lining with an impervious material. The secondary containment system shall be a minimum of one and one-half (1-1/2) times the contents of the largest tank in accordance with the Fire Code. Drip pots shall be provided at the pump out connection to contain the liquids from the storage tank. All tanks shall be set back pursuant to the standards of the Commission and the Fire Code. Each storage tank system shall be equipped with a level control device that will automatically activate a valve to close the Well in the event of excess liquid accumulation in the tank system. No meters, storage tanks, separation facilities, or other above ground facilities, other than the wellhead and flow lines, shall be placed in a floodway identified by FEMA on the most current FIRM. Meters, storage tanks, separation facilities, or other above ground facilities proposed in the floodplain shall be outside of the floodway and shall be subject to approval by the Building Official.
- (y) Swabbing, bailing and purging Wells. No person shall begin the operation of swabbing a Well without first complying with the provisions of this Section. In swabbing, bailing or purging a Well, all deleterious substances removed from the borehole shall be placed in appropriate tanks and no substances shall be permitted to pollute any surface or subsurface fresh water. No Well shall be swabbed before a device, commonly known as a lubricator, has been placed on the flow casing above all outlets or flow lines of the Well. The lubricator shall be not less in diameter than the flow casing and equipped with an adequate oil saver or stuffing box at the top. The total inside length of the lubricator shall be not less than five feet (5') more than the total length of swab and turn back on swab line. The lubricator shall have a nipple not less than two inches (2") in diameter nor more than four inches (4") in length, placed not more than six inches (6") from the top of the flow line or lines between the gate valve on the flow lines and flow casings. The nipple shall be provided with a gate valve not less than two inches (2") in size. All equipment and parts of the lubricator shall be of a type designed and tested to withstand a pressure of 3,000 pounds per square inch. All pressure tests shall be by the hydrostatic method.
- (z) No refinery, processing, treating or absorption plant of any kind, shall be constructed, established or maintained within the Airport except as necessary

to render gas into a quality suitable for delivery to third party pipelines. Natural gas fractionation will require a separate permit.

- (aa) Surface casing. Surface casing shall be in full compliance with the applicable rules and regulations of the Commission. Surface casing shall have a centralizer in the middle of the shoe joint, a centralizer on the top of the second joint of casing, and centralizers every fourth joint. Surface casing must be new pipe of API grade J or K or higher grade and have a minimum burst pressure rating of 2,900 psi. In the event a rupture, break or opening occurs in the surface or production casing, the Operator or drilling contractor shall promptly report the incident to the Building Official. Immediate action shall be taken to repair such casing and the Building Official shall be given the opportunity to witness the repairs.
- (bb) Valves. Each well must have a shutoff valve to terminate the Well's production. The Fire Department shall have access to the Well site to enable it to close the shut-off valve in an emergency.
- (cc) Storage. Any permanent, temporary or portable tank, vessel, container, pit or impoundment used for storage of products, materials or wastes shall be selected and maintained to be fit for the purpose and capacity in which it will be used. Any such storage shall only be used for materials and wastes from oil and gas exploration and production activities within the boundaries of Dallas/Fort Worth Airport. All waste shall be disposed of in such time, place and manner as to comply with the air and water pollution control regulations of the Federal Government, the State, this Resolution and any other applicable requirement of the Airport Board.
- (dd) Watchperson. The Operator must keep a watchman or security personnel on site during the Drilling or re-working of a Well when other workers are not on the premises.
- (ee) Installation of pipelines on, under or across Airport property. The Operator shall apply to the Airport Board for a Permit to use the Airport for the purpose of constructing, laying, maintaining, operating, repairing, replacing and removing pipelines. Prior to installation, the owner of the pipeline shall submit to the Building Official the pipeline design criteria, including but not limited to, operating pressures, pipeline gradient and elevation to sea level, location, pipe ASTM grade, and pipe wall thickness. Prior to and subsequent to installation of each segment of new or replacement pipeline, the pipe and pipeline must receive and pass on-site inspection of compliance with the design criteria and the process of installation. All new or replacement pipe or pipelines shall be covered and must be at least 48 inches below the existing ground level as verified and approved by the Building Official. Operator shall:

- (1) Not interfere with or damage existing water, sewer or gas lines or the facilities of public utilities located on, under or across a Street.
- (2) Furnish to the Building Official a site plan showing the location of such pipelines.
- (3) Design, construct, maintain and operate natural gas pipelines in accordance with 49 U.S.C. 60101, et seq.; 49 Code of Federal Regulations (CFR) Part 191, Transportation of Natural and Other Gas by Pipeline; Annual Reports, Incident Reports, and Safety-Related Condition Reports; 49 CFR Part 192, Transportation of Natural and Other Gas by Pipeline: Minimum Federal Safety Standards; and 49 CFR Part 193, Liquefied Natural Gas Facilities: Federal Safety Standards.
- (4) Grade, level and restore such property to the same surface condition, as nearly as practicable, as existed prior to the laying of the pipeline.
- (5) If a pipeline becomes unsafe or is not properly maintained, or in the event a leak is detected, the Operator of the line shall immediately evaluate the leak or release and either shut in the pipeline or, as soon as possible, shall initiate repairs according to the procedure in section (oo) below.
- (6) As mandated by DOT requirements under CFR 192.701, each owner or operator of a gas pipeline for which a Permit is required under this Resolution shall have it surveyed at least twice each year with intervals not to exceed 7.5 months for the purpose of determining whether it is in safe condition and free from leaks, breaks or open spaces. The owner or operator shall provide a copy of the leakage survey report required under DOT CFR 192.706 supported by an affidavit by the person making the survey to the DFW Department of Public Safety Fire Prevention Office, within 30 days of completion of the survey. For failure to timely make the survey and report, or if the report discloses or it otherwise appears that any line is leaking, defective or unsafe, the pipeline shall be closed and shut-in until such time as the leak has been repaired, or a repair plan or report has been approved by the Building Official.
- (7) The location of all new or replacement pipe or pipelines shall be marked by the owner(s) thereof or by the person installing or operating the pipe or pipeline. Marker signs shall be placed at all locations where pipe or pipelines cross property boundary lines and at each side of a Street which the pipe or pipeline crosses. The top of all marker signs shall be a minimum of four feet (4') above ground level, and the support post must be sufficient to support the marker sign and shall be painted yellow or such other color as may be approved by the Building Official. All marker signs shall comply with US Department of Transportation standards regarding size, shape, color, installation, positioning, maintenance and

other related signage requirements. It is the joint and severable responsibility of the owner and the operator of any and all pipelines to maintain the markers in accordance with this Section.

- (ff) Streets. No Permit shall be issued for any Well to be drilled within any Street, and no Street shall be blocked, encumbered, or closed due to any Exploration, Drilling or production operations.
- (gg) Vehicle routes. Vehicles associated with Drilling and/or production in excess of three (3) tons shall be restricted to those arterials or routes designated by the Airport.
- (hh) Tank specifications for a Gas Well. All tanks and permanent structures shall conform to the API specifications unless other specifications are approved by the Airport Board. The top of the tanks shall be no higher than twelve feet (12') above the terrain surrounding the tanks.
- (ii) All Drilling, re-entry and operations at any Well shall be conducted using the best available technology. All casing, valves, Blowout Preventers, drilling fluids, tubing, Braden head, Christmas tree and wellhead connections shall be of a type and quality consistent with sound engineering practices. The setting and cementing of casing and running of drill stem tests shall be performed in a manner consistent with the best available technology. All persons engaged in Drilling or production operations shall observe and follow the recommendations and regulations of the API and the Commission, except in those instances specifically addressed by this Resolution.
- (jj) Upon Completion of the Well, the Operator shall provide a copy of the Commission Completion Report W15, and certify by affidavit that the Well has been completed according to good engineering practices. The affidavit shall stipulate the number of sacks of cement, the class of cement, blended materials, and weight of cement in pounds per gallon; cement displacement pressure, final pumping pressure and whether check valves held the pressure. Commencement and completion times of such operation shall be stipulated. The affidavit must be completed by a cementing service company and signed by both the Operator and the cementing service company.
- (kk) No person shall commence any operation to change the equipment of a Well for the purpose of cleaning, repairing or reconditioning any such Well, before notifying the Building Official that such operation is to be commenced. No person shall commence such operation unless he receives approval. The Building Official shall give approval for converting from natural to artificial production if it appears that the provisions of this Resolution have been and are being complied with.
- (ll) In no case shall Gas or air be transported through any pipeline at a working pressure in excess of 1,000 pounds. If it is necessary to use greater working

pressure, a gas or air booster plant shall be installed not closer than 75 feet from the Derrick floor of a Well or tank battery and the compressor unit not less than 100 feet from the Derrick floor of the Well being served. In no event shall more than 1,500 pounds working pressure be used in flowing a Well by artificial means.

- (mm) All Gas gathering lines and pipelines on DFW Airport shall be designed, installed, tested and maintained in accordance with the most current version of 49CFR192 – Transportation of Natural or Other Gas by Pipeline: Minimum Federal Safety Standards. All permanent fresh water and Brackish water HDPE lines shall be tested to ASTM D-2837 following installation or repair.
- (nn) At each Well where air or gas lift is used, there shall be placed on the air or gas lift an indicating pressure gauge which shall show the working pressure of air or gas delivered to the Well at all times. All gauges installed on lines shall be tested and corrected every six (6) months.
- (oo) The Building Official shall inspect all pressure lines in use at any Well or at any project to ensure that tubing, fittings, equipment or connections are reasonably tight, safe and free from leaks. If it becomes necessary to change or remove any pipeline, the entire expense of change or removal shall be borne by the owner of the line requiring repair. Each leak noted shall be classified by a qualified person as to its risk to people and property based on the leak location, line use and content, line pressure, surrounding land use and other considerations. Each leak shall be classified upon discovery, and a repair schedule shall be developed to make repairs as soon as possible, but not to exceed one month. The leak shall be monitored regularly until repairs are made. All such repair plans shall be submitted to and approved by the Building Official.
- (pp) All pipelines, connections and fixtures installed or used for the purpose of gas transportation shall be operated and maintained in a safe manner at all times so as to prevent all leakage or escape of their contents.
- (qq) The Building Official shall have the authority to require the immediate shutting in or closing of any Well if he finds there exists, within a 100-foot radius of any Well, any Gas or gasoline vapor in a quantity sufficient to constitute, in his sole judgment, or in the sole judgment of the Fire Chief, a fire hazard. The Well shall remain shut in or closed in until the hazard and its cause have been remedied.
- (rr) In the event of a fire or discovery of a fire, smoke, or unauthorized release of flammable or hazardous materials, the Operator shall immediately report such condition to the Fire Department.
- (ss) Every Disposal Well shall be constructed so as to seal the injection zone from the upper portion of the casing. Cement shall be circulated to the surface for

injection zone casing. The annulus between the casings shall be filled with a non-corrosive fluid, then sealed and a 1/4-inch female fitting with cutoff valve shall be attached so that the pressure annulus may be measured by the Building Official by attaching a gauge with a 1/4-inch male fitting. The annulus between the production casing and the injection tubing shall be pressure tested to a pressure at least 250 psi greater than the injection pressure proposed for the Well. The Building Official shall be given the opportunity to witness and approve the pressure testing. A copy of all H-5 test reports must be provided to the Building Official. A pressure shall be maintained in the annulus sufficient to monitor the fluids in the annulus. Any significant deviation from the established pressure shall be cause to shut down the Well, and may result in cancellation of the operating Permit, until the established pressure can once again be maintained.

- (1) The DFW Airport Permit for Disposal Well shall reflect the maximum injection pressure as permitted by the Commission. Exceeding this injection pressure shall be considered a violation of this Section.
- (2) Injection lines for such wells shall be buried to a minimum depth of four feet (4'), and shall be pressure tested (static) annually at a minimum of 150 percent of the pressure normally encountered at the injection pump discharge for a period of hours to be fixed by the Building Official. The Building Official shall be notified in writing five (5) days in advance of such test and may supervise it. Test results shall be filed with the Building Official upon completion.
- (3) Before performing any down-hole work on a Disposal Well, the Operator shall notify the Building Official at least five (5) days in advance of performing the work, or as soon as practical in the event of emergency repair work. The Building Official shall be given the opportunity to witness the installation of tubing and packer in the Disposal Well. The annulus between the injection tubing and the production casing shall then be pressure tested as required by Commission Rule 3.9.12 Testing. The Building Official shall be given the opportunity to witness the pressure testing of this annulus.
- (3) The Operator of the well shall submit to the Building Official all reports and notifications at the same frequency that such reports and notifications are required under TX RRC Rule 3.9 Disposal Wells, or its equivalent.

SECTION 15 SCREENING

Throughout the entire Exploration, Drilling, and production process there shall be screening improvements (fences, walls, Berms and landscaping) required during each phase of the process if the Drill Site or Operation Site is visible from a Building or

Street, exclusive of construction roads, haul roads or access roads. Without regard to visibility, each Fresh Water Fracking Pit that is open to the atmosphere or surface shall be screened.

- (1) During Drilling. A temporary chain link fence with all-weather screening fabric at least six feet (6') in height shall be established around the entire Operation Site to obscure view of the Drilling activities. A secured entrance gate shall be required. All gates are to be kept locked when the Operator or his employees are not within the enclosure. A "Knox Padlock" or "Knox Box with a key" shall be provided to access the Well site to be used only in case of an emergency.
 - (2) Completion through Abandonment (production phase). A painted architectural metal fence or other approved fencing and/or screening shall be required to enclose and visually screen the Well and all associated equipment. An earthen Berm may also be required. The masonry walls, Berms, and landscaping shall be in compliance with standard engineering and design practices and shall meet the following minimum requirements:
 - a. The painted architectural fence or other approved fencing and/or screening material and design shall be generally compatible with the design of similar facilities, Building and structures on and/or adjacent to the site as approved by the Building Official; and
 - b. Painted architectural fences shall be at least eight feet (8') in height.
 - (3) Each Fresh Water Fracking Pit shall be surrounded by a temporary chain link fence with all-weather screening fabric at least six feet (6') in height. A secured entrance gate shall be required. All gates are to be kept locked when the Operator or his employees are not within the enclosure. A "Knox Padlock" or "Knox Box with a key" shall be provided to access the Well site to be used only in case of an emergency. If the Fresh Water Fracing Pit is open to the atmosphere or the surface, it shall be covered by netting sufficient to inhibit access to the pit by fowl.
- (b) Gate specifications. All temporary fences and masonry walls shall be equipped with at least one (1) gate. The gate shall meet the following specifications:
- (1) At least one gate shall be not less than twelve feet (12') wide and be composed of two (2) gates, each of which is not less than six feet (6') wide, or one (1) sliding gate not less than twelve feet (12') wide. If two (2) gates are used, gates shall latch and lock in the center of the span;
 - (2) The gates shall be of chain link construction, with all-weather screening fabric, that meets the applicable specifications, or of other approved

material that, for safety reasons, shall be at least as secure as a chain link fence;

- (3) The gates shall be provided with a combination catch and locking attachment device for a padlock, and shall be kept locked except when being used for access to the site; and
- (4) Operator must provide the Fire Department with a “Knox Padlock” or “Knox Box with a key” to access the Well site to be used only in case of an emergency.

SECTION 16 CLEANUP AND MAINTENANCE

- (a) Cleanup after well servicing. After the Well has been completed or there has been an Abandonment, the Operator shall clean the Drill Site or Operation Site, complete restoration activities and repair all damage to property caused by such operations within sixty (60) days.
- (b) Clean-up after spills, leaks and malfunctions. After any spill, leak or malfunction, the Operator shall remove or cause to be removed to the satisfaction of the Fire Department and the Building Official all waste materials from any property affected by such spill, leak or malfunction. Clean-up operations must begin immediately. If the Operator fails to begin clean-up within twenty-four (24) hours, the Airport Board shall have the right to contact the Commission in order to facilitate the removal of all waste materials from the property affected by such spill, leak or malfunction.
- (c) Painting. All production equipment shall be painted and maintained at all times, including wellheads, pumping units, tanks, and Buildings. When requiring painting of such facilities, the Building Official shall consider the deterioration of the quality of the material of which such facility or structure is constructed, the degree of rust, and its appearance. Paint shall be non-reflective and of a neutral color, compatible with surrounding uses. Neutral colors shall include sand, gray and unobtrusive shades of green, blue and brown, or other neutral colors approved by the Building Official.
- (d) Blowouts. In the event of the loss of control of any Well, Operator shall immediately take all reasonable steps to regain control regardless of any other provision of this Resolution and shall notify the Building Official and Fire Chief as soon as practicable. If in the opinion of the Building Official or the Fire Chief, a danger to persons and/or property exists because of such loss of Well control and that the Operator is not taking or is unable to take all reasonable and necessary steps to regain control of such Well, the Building Official may then employ any well control expert or experts or other contractors or suppliers of special services, or may incur any other expenses for labor and material which

the Building Official deems necessary to regain control of such Well. The Airport Board shall then have a valid lien against the interest in the Well of all working interest owners to secure payment of any expenditure made by the Airport Board pursuant to such action of the Building Official in gaining control of said Well.

SECTION 17 PLUGGED AND ABANDONED WELLS

- (a) Surface requirements for the Abandonment of a Well. Whenever Abandonment occurs pursuant to the requirements of the Commission, the Operator shall be responsible for the restoration of the Well site to its original condition as nearly as practicable, in conformity with the regulation of this Resolution.
- (b) Abandonment shall be approved by the Building Official after restoration of the Drill Site and/or Operation Site has been accomplished in conformity with the following requirements at the discretion of the Building Official:
 - (1) The Derrick and all appurtenant equipment thereto shall be removed from the site;
 - (2) All tanks, towers, and other surface installations shall be removed from the site;
 - (3) All concrete foundations, piping, wood, guy anchors and other foreign materials regardless of depth, except surface casing, shall be removed from the site, unless otherwise directed by the Commission;
 - (4) If any soil was contaminated, it shall be removed in accordance with local, State and Federal regulations;
 - (5) All holes and depressions shall be filled to grade with clean, compactable soil;
 - (6) All waste, refuse or waste material shall be removed; and
 - (7) During Abandonment, Operator shall comply with all applicable sections in this Resolution.
- (c) Abandoned Well requirement. The Operator shall furnish the following to the Building Official:
 - (1) A copy of the approval of the Commission confirming compliance with all Abandonment proceedings under state law; and

(2) A notice of intention to abandon under the provisions of this Section and stating the date such work will be commenced. Abandonment may then be commenced on or subsequent to the date so stated.

(d) Abandonment requirements prior to new construction. A Well Site or Drill Site where there has been Abandonment shall meet the most current Abandonment requirements of the Commission prior to the issuance of any Permit for development of the property. No structure shall be built over an abandoned well.

(e) The Operator can only abandon a Well if the Building Official has reviewed and approved the Abandonment.

SECTION 18 TECHNICAL ADVISOR

The Airport Board may from time to time employ a technical advisor or advisors who are experienced and educated in the gas industry or the law as it pertains to gas matters. The function of such advisor(s) shall be to advise, counsel or represent the Airport Board on such matters relating to gas operations within the Airport as the Airport Board may want or require and the effect thereof, both present and future, on the health, welfare, comfort and safety of the public. In the event such technical advisor(s) is (are) employed for the purpose of advising, counseling or representing the Airport Board relative to an Operator's unique and particular set of circumstances, case or request relating to this Resolution, then the cost for such services of such technical advisor(s) shall be assessed against and paid for by such Operator in addition to any fees or charges assessed pursuant to this Resolution. Prior to the employment of a technical advisor, the Airport Board shall inform the Operator of the intended scope of work and the estimated costs and expenses.

SECTION 19 MEANS OF APPEAL

Refer to Part One, Construction and Fire Prevention Standards Resolution for Board of Appeals.

SECTION 20 VARIANCE RESOLUTION COMMITTEE

The Airport Board hereby establishes a Variance Resolution Committee for Gas Exploration and Production, hereinafter referred to as the Variance Resolution Committee, for the purpose of considering variances to the requirements of Part Nine. The Variance Resolution Committee shall consist of the following Airport staff positions:

Vice President, Commercial Development or successor department
Vice President, Department of Public Safety or successor department

Vice President, Finance or successor department
Vice President, Operations or successor department
Vice President, Planning or successor department

- (a) An Applicant for a Permit required by this Part may apply for a variance from the requirements of this Part by submitting to the Building Official a written request for variance. The request must include the following:
- (1) Description of the requested variance and an explanation of why it should be granted;
 - (2) Description of alternatives considered and why each is not the preferred alternative;
 - (3) Description of the economic consequences if the variance is not granted; and
 - (4) Description of how the level of health, safety and welfare of the public will be maintained if the variance is granted.
- (b) The Building Official shall forward copies of the variance request to the Variance Resolution Committee members. On a case-by-case basis, the Variance Resolution Committee shall consider the following in granting a variance:
- (1) Whether the operations proposed are safe and reasonable under the circumstances and conditions prevailing in the area, considering the particular location and the character of the improvements located there;
 - (2) How the operations proposed compare to available alternatives;
 - (3) Whether the operations proposed would conflict with the orderly growth and development of the Airport;
 - (4) The economic consequence if the variance is not granted;
 - (5) Whether the operations proposed adequately protect the health, safety and welfare of the public; and
 - (6) Whether the operations proposed provide acceptable access for fire personnel and firefighting equipment.
- (c) Approval of a variance requires that a minimum of three Variance Resolution Committee members vote in favor of the approval. The Variance Resolution Committee shall notify the Airport tenants affected by any request for variance and allow them to address the request in writing within twenty (20) days of the notice. Only variances that would result in a setback distance between any Well

or Disposal Well and a Building to less than the minimum setback outlined in Section 13 of this Part will be deemed to affect an Airport tenant.

The Variance Resolution Committee shall not be required to hold public hearings, except upon request of two Committee members. The Variance Resolution Committee shall notify the Airport Board in writing of each variance request at least twenty (20) days prior to the granting of such variance. Upon request of two voting Airport Board members, a variance shall be placed on a public meeting agenda of the Airport Board. The Variance Resolution Committee shall not thereafter grant the variance request without consent of the Airport Board.

The details of each action granting or denying the requested variance shall be recorded and entered in the files of the Office of the Building Official, and the Building Official shall forward a letter to the Applicant stating whether the Variance Resolution Committee has approved or denied the variance request and listing any conditions placed upon an approval. The Variance Resolution Committee shall report each such action to the Airport Board on at least a quarterly basis.

SECTION 21 SEVERABILITY CLAUSE

It is the intention of the Airport that the phrases, clauses, sentences, paragraphs and sections of this Resolution are severable, and if any phrase, clause, sentence, paragraph or section of this Resolution shall be declared unconstitutional or unenforceable by the valid judgment or decree of any court of competent jurisdiction, such unconstitutionality or unenforceability shall not affect any of the remaining phrases, clauses, sentences, paragraphs and sections of this Resolution.

September 13, 2022

STATE OF TEXAS §

COUNTY OF DALLAS §

COUNTY OF TARRANT §

I, Donna J. Schnell, Board Staff Secretary of the Dallas Fort Worth International Airport Board, do hereby certify that the attached is a true and correct copy of Resolution No. 2022-08-174, approved by the Dallas-Fort Worth International Airport Board of Directors at its Board Meeting held on August 4, 2022.

WITNESS MY HAND AND SEAL OF THE DALLAS-FORT WORTH INTERNATIONAL AIRPORT BOARD, this 13^h day of September 2022.



Donna J. Schnell
Board Staff Secretary

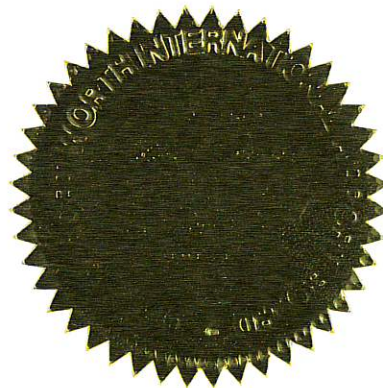

**DALLAS FORT WORTH INTERNATIONAL AIRPORT BOARD
OFFICIAL BOARD ACTION/RESOLUTION**

Date 08/04/2022	Committee Finance/Audit	Subject Amendments to DFW Airport Code of Rules and Regulations	Resolution # 2022-08-174
---------------------------	-----------------------------------	---	------------------------------------

Action
That the Airport Board approve, and request the Cities of Dallas and Fort Worth to approve, amendments to DFW International Airport's Code of Rules and Regulations.

Description of Code Changes:

- Chapter 2 (Traffic Regulation): In Section 2-4, the requirement that a vehicle parked in violation of this Code must also represent an operational hazard before it can be towed will be deleted.
- Chapter 8 (Commercial Activities): A new Section 8-18 is being added to require that certificate of occupancy holders on any building at the airport more than 30 years old must comply with a self-inspection program to be approved by the Board.

Justification

- The first change will allow the Board greater flexibility to enforce the rules against illegal commercial activity in the parking facilities.
- The second change will provide much greater assurance that older buildings do not constitute a safety hazard.

D/S/M/WBE Information

Contract #	Agreement #	Purchase Order #	Action Amount \$0	Revised Amount \$0
-------------------	--------------------	-------------------------	-----------------------------	------------------------------

For Information contact Elaine Rodriguez 3-5480	Fund	Project #	External Funding Source	Amount \$0
--	-------------	------------------	--------------------------------	----------------------

Additional Information

Additional Attachments: **Y**

BE IT RESOLVED BY THE DALLAS FORT WORTH INTERNATIONAL AIRPORT BOARD

That the Airport Board approve, and request the Cities of Dallas and Fort Worth to approve, amendments to DFW International Airport's Code of Rules and Regulations.

Approved as to Form by



Rodriguez, Elaine
Legal Counsel
Jul 19, 2022 3:34 pm

Approved as to Funding by

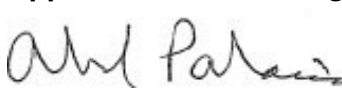

Palacios, Abel
Vice President Finance
Finance
Jul 19, 2022 4:42 pm

Approved as to M/WBE by



Lee, Tamela
Vice President Business Diversity
and Development
Business Diversity and
Development
Jul 20, 2022 9:59 am

SIGNATURE REQUIRED FOR APPROVAL

Approved by



Department Head
Legal
Jul 19, 2022 3:25 pm



Chief Executive Officer

Aug 4, 2022 2:37 pm

Date

Chapter 2 Traffic Regulation

ARTICLE I. IN GENERAL.

- Sec. 2-1. Traffic Control Installations.
- Sec. 2-2. Definitions.
- Sec. 2-3. Law Enforcement.
- Sec. 2-4. Towing.
- Sec. 2-5. Speed Limits.

ARTICLE II. AIRSIDE TRAFFIC.

- Sec. 2-6. Authority to Operate on the AOA.
- Sec. 2-7. Reckless Driving.
- Sec. 2-8. Obedience to Signs.
- Sec. 2-9. Parking on the AOA.
- Sec. 2-10. Motor Vehicle Accidents.
- Sec. 2-11. Driving Under the Influence.
- Sec. 2-12. Safety Belts.

ARTICLE III. PARKING VIOLATIONS.

- Sec. 2-13. Obedience to Signs.
- Sec. 2-14. Fire Lane.
- Sec. 2-15. Failure to Park in Marked Space.
- Sec. 2-16. Employee Parking Areas.
- Sec. 2-17. Parking by Air Operation Areas Fences.

- Sec. 2-18. Passenger Loading Zones – No Unattended Vehicle.
- Sec. 2-19. Impeding Flow of Traffic.
- Sec. 2-20. Material Loading Zones.
- Sec. 2-21. Failure to Pay Parking and Access Charges
- Sec. 2-22. Parking Defenses.

**ARTICLE IV.
ADMINISTRATIVE ADJUDICATION OF PARKING VIOLATIONS.**

- Sec. 2-23. Parking Violations Made Civil Offenses.
- Sec. 2-24. Hearing Requirement.
- Sec. 2-25. Hearing Officers; Powers, Duties and Functions.
- Sec. 2-26. Parking Citations Form.
- Sec. 2-27. Service of a Parking Citation; Presumption of Service.
- Sec. 2-28. Liability of the Vehicle Owner and Operator; Presumption of Liability.
- Sec. 2-29. Answering a Parking Citation.
- Sec. 2-30. Adjudication by Mail, Electronic Mail or through the Online Citation Appeal System
- Sec. 2-31. Hearings for Disposition of a Parking Citation; Notice of Decision.
- Sec. 2-32. Civil Fine Schedule.
- Sec. 2-33. Enforcement of Order.
- Sec. 2-34. Removal of Immobilization Device.
- Sec. 2-35. Immobilization/Impoundment Hearing.
- Sec. 2-36. Appeal from Hearing.
- Sec. 2-37. Disposition of Civil Fines, Penalties, and Costs.

**ARTICLE I.
IN GENERAL.**

SEC. 2-1. TRAFFIC CONTROL INSTALLATIONS.

The Airport Board is authorized to establish all traffic control devices, signs, signals, markings and insignias on the Airport.

SEC. 2-2. DEFINITIONS.

The definition of a term in this chapter shall apply only to this chapter.

ABANDONED VEHICLE shall have the meaning assigned in Section 683.002 of the Texas Transportation Code.

ADMINISTRATOR shall mean the Vice President of the Transportation Business Unit of the Dallas-Fort Worth International Airport Board.

AIR OPERATIONS AREA or "AOA" shall mean the area of the Dallas-Fort Worth International Airport bounded by a fence or to which access is otherwise restricted and which is primarily used or intended to be used for landing, taking-off or surface maneuvering of aircraft. The AOA does not include those leasehold areas within or having direct access to the AOA which are subject to security requirements imposed on the lessee or tenant under appropriate federal regulations or agreement incorporated in a signed lease.

AIRCRAFT RESCUE AND FIRE FIGHTER ROAD (AARF) or EMERGENCY ACCESS ROADS shall mean roads on the AOA that are maintained to support emergency responses.

AUTHORIZATION or AUTHORIZED shall mean acting under or pursuant to a written contract, permit, authorization or other evidence of right issued by the CEO or his designee.

BADGE shall mean an identification card issued by the Airport to identify a person with access authorization.

DISABLED PARKING PLACARD shall mean the placard issued by the state under section 681.002 of the Texas Transportation Code, as amended.

DISABLED PERSON shall mean a person who has a permanent or temporary disability within the meaning of Section 681.001 in the Texas Transportation Code, as amended, and who has applied for and received:

- (a) a disabled person or disabled veteran license plate from the state;
- (b) a disabled parking placard from the state; or

(c) a license plate or placard bearing the international symbol of access issued by a U.S. state or by a state or province of a foreign country.

DISABLED PERSON LICENSE PLATE shall mean the specially designed license plate of a vehicle, issued by the state to a permanently disabled person under Section 504.201 of the Texas Transportation Code, as amended.

DISABLED VETERAN LICENSE PLATE shall mean the specially designed license plate of a vehicle, issued by the state to a disabled veteran under Section 504.202 of the Texas Transportation Code, as amended.

ESCORT shall mean to accompany and monitor the activities of an individual who does not have unescorted access authority into or within a sterile area, secured area or SIDA.

INTERNATIONAL SYMBOL OF ACCESS shall have the meaning defined in Section 681.001 of the Texas Transportation Code, as amended.

JUNKED VEHICLE shall have the meaning defined in Section 683.071 of the Texas Transportation Code.

MOVEMENT AREA shall mean the area of the AOA utilized for taxiing, takeoff, and landing of aircraft and includes adjacent undeveloped areas. The movement area does not include loading ramps and parking area ramps.

NON-MOVEMENT AREA shall mean the area that includes all aircraft parking areas, loading ramps and aircraft maintenance ramps.

OPERATOR shall mean any person in control of a vehicle, including a railroad train or a vehicle being towed.

OWNER shall mean a person in whose name the legal title of an aircraft or a motor vehicle is held or vested.

PARK or **PARKING** shall mean to stand an occupied or unoccupied vehicle, other than temporarily while loading or unloading merchandise or passengers.

PARKING and ACCESS CHARGES are specified in the Dallas-Fort Worth International Airport Board Schedule of Charges.

PARKING BAN shall mean certain hours or times during which standing, parking, or stopping of a vehicle is prohibited along the curb of designated street as indicated by signs.

REGULATED VEHICLE means a taxicab or prearranged service vehicle.

RESTRICTED AREA shall mean any area locked or posted by the Airport to either prohibit or limit entry or access to specific authorized persons.

STAND or **STANDING** shall mean to halt an occupied or unoccupied vehicle, other than temporarily while receiving or discharging passengers.

STOP or **STOPPING** shall mean:

- (a) when required, to completely cease movement; and,
- (b) when prohibited, to halt, including momentarily halting, an occupied or unoccupied vehicle, unless necessary to avoid conflict with other traffic or to comply with the directions of a police officer or a traffic control sign or signal.

UNATTENDED VEHICLE shall mean a vehicle that is stopped or parked and whose driver and passengers have exited the vehicle and moved more than 50 feet away from the vehicle leaving, it unoccupied.

VEHICLE shall mean and include automobiles, trucks, buses, motorcycles, horse-drawn vehicles, bicycles, pushcarts and any other device in or upon or by which any person or property is or may be transported, carried, or drawn upon land.

VEHICULAR PARKING AREA shall mean those portions of the Airport designated and made available temporarily or permanently by the Airport Board for the parking of vehicles.

SEC. 2-3. LAW ENFORCEMENT.

Texas peace officers commissioned by the Airport Board shall have primary law enforcement authority within the boundaries of the Airport. In addition to DPS law enforcement officers, the Administrator, and the representatives and agents designated by the Administrator, shall have enforcement authority as to civil offenses related to parking or stopping a vehicle.

SEC. 2-4. TOWING.

- (a) Any vehicle which is abandoned or junked, or parked in violation of this Code, ~~and represents an operational hazard at the Airport,~~ may be removed or towed away and impounded, all at the operator's or owner's expense and without liability for any damage to the vehicle. Such expense shall be a lien against the vehicle and payment in full shall be a prerequisite to the reclaiming of the vehicle by the operator or owner.
- (b) Any boat, trailer, storage compartment or other like property left in any parking facility on the Airport without authorization from the CEO will be towed away and impounded all at the operator's or owner's expense and without liability for any damage to the vehicle.

SEC. 2-5. SPEED LIMITS.

The speed limits upon the streets, ways, passages and vehicular routes within the boundaries and confines of the Airport are set, affirmed and ratified as described in Appendix I of this Code. Unless otherwise provided, the maximum speed limit on streets, ways, passages and vehicular routes within the boundaries and confines of the Airport shall be thirty (30) miles per hour. The streets, ways, passages and vehicular routes, and their corresponding block numbers within the boundaries and confines of the Airport, are set, affirmed, and ratified as described in Appendix I of this Code.

**ARTICLE II.
AIRSIDE TRAFFIC.**

SEC. 2-6. AUTHORITY TO OPERATE ON THE AOA.

(a) A person commits an offense if he is on the AOA and:

- (1) does not display evidence of authorization issued by the Airport Board;
or
- (2) is not under authorized escort as described in Chapter 9.

(b) A person commits an offense if he operates a motor vehicle on the AOA and:

- (1) does not have a valid government issued driver's license in his possession;
- (2) does not have a license in his possession that is appropriate for the type of vehicle being operated; or,
- (3) does not display or refuses to present a driver's license upon demand by a peace officer.

SEC. 2-7. RECKLESS DRIVING.

A person commits an offense if he operates a motor vehicle on the AOA in a willful or wanton disregard for the safety of persons or property.

SEC. 2-8. OBEDIENCE TO SIGNS.

A person commits an offense if while on foot or operating any vehicle on the AOA:

- (a) he disregards a posted regulatory sign, special sign, signal, marking or device used to regulate, warn, or guide traffic; or

- (b) fails to comply with directions given by the control tower, a law enforcement officer, or a person designated by the Airport to control traffic.

SEC. 2-9. PARKING ON THE AOA.

A person commits an offense if he parks a motor vehicle, vehicle, trailer, or other equipment on the AOA:

- (a) in a manner contrary to any posted regulatory signs, traffic control devices or pavement markings; or
- (b) in any manner that prevents the passage or movement of aircraft, vehicles, trailers or pedestrians; or
- (c) in any manner that obstructs access to fuel shutoff valves, fire suppression equipment, or other emergency systems; or
- (d) that is inoperable or undergoing maintenance; or
- (e) that the Administrator or his designee instructed the person to remove from the AOA.

SEC. 2-10. MOTOR VEHICLE ACCIDENTS.

Any person operating a motor vehicle on the AOA which is involved in an accident resulting in injury to any person or damage to another's property shall:

- (a) immediately stop at the scene or as close as possible;
- (b) render aid if necessary;
- (c) exchange driver, vehicle, and insurance information if necessary; and
- (d) notify the DFW Airport DPS and the Airport Operations Center.

SEC. 2-11. DRIVING UNDER THE INFLUENCE.

A person commits an offense if he operates a motor vehicle on the AOA and:

- (a) has any detectable amount of alcohol in the person's system;
- (b) has any detectable amount of a dangerous drug in the person's system; or,
- (c) does not have the normal use of his mental or physical faculties by reason of the introduction of a controlled substance, a drug, a combination of two or more substances or any other substance into the body.

SEC. 2-12. SAFETY BELTS.

- (a) A person commits an offense if the person:

- (1) is operating or riding in a vehicle,
 - (2) is occupying a seat that is equipped with a safety belt, and
 - (3) is not secured by a safety belt while the vehicle is being operated in either the movement area or non-movement area of the Air Operations Area.
- (b) In this section, “safety belt” and “secured” have the meanings assigned by Section 545.412 of the Texas Transportation Code.
- (c) It is a defense to prosecution under this section that:
- (1) the person is engaged in servicing an aircraft and is driving or riding in a vehicle located within 25 feet of that aircraft;
 - (2) the person is driving or riding in a vehicle within a baggage make-up area and the person is present for the purpose of positioning equipment;
 - (3) the person is an emergency service provider performing his official duties;
 - (4) the person possesses a written statement from a licensed physician stating that for a medical reason the person should not wear a safety belt; or
 - (5) the person presents to the court, not later than the 10th day after the date of the offense, a written statement from a licensed physician stating that for a medical reason the person should not wear a safety belt.

**ARTICLE III.
PARKING VIOLATIONS.**

SEC. 2-13. OBEDIENCE TO SIGNS.

- (a) A person commits an offense if, as the operator of a vehicle, he stops, stands, or parks a vehicle within the boundaries of the Airport in violation of an official sign, curb marking, or street marking prohibiting, regulating, or restricting the parking, stopping, or standing of vehicles, except when necessary to avoid conflict with other traffic or to be in compliance with the law or the directions of a police officer.
- (b) A person commits an offense if he:
- (1) is not a disabled person or transporting a disabled person and stops, stands, or parks a vehicle with a valid disabled person license plate, a disabled veteran license plate, a disabled parking placard, or a license

plate or placard bearing the international symbol of access in a parking space or area designated specifically for the disabled;

- (2) stops, stands, or parks a vehicle that does not display a valid disabled person license plate, a disabled veteran license plate, a disabled parking placard, or a license plate or placard bearing the international symbol of access in a parking space or area designated specifically for the disabled; or
- (3) stops, stands, or parks a vehicle in such a manner that the vehicle blocks an access or curb ramp or any other architectural improvement designed to aid the disabled.

SEC. 2-14. FIRE LANE.

A person commits an offense if the person stops, stands, or parks a vehicle in a fire lane except when necessary to avoid conflict with other traffic or to be in compliance with the law or the directions of a police officer.

SEC. 2-15. FAILURE TO PARK IN MARKED SPACE.

A person commits an offense if, in an Airport operated parking area, he parks a vehicle in a marked parking space and fails to park within the lines as designated.

SEC. 2-16. EMPLOYEE PARKING AREAS.

A person commits an offense if he operates, parks, or stands a motor vehicle within an Airport operated parking area designated for employee parking unless a valid permit, decal, or other authorization issued by the Airport is displayed on the vehicle in a manner established by the Administrator.

SEC. 2-17. PARKING BY AIR OPERATION AREAS FENCE.

A person commits an offense if he parks a vehicle or leaves other property within ten (10) feet of an AOA fence.

SEC. 2-18. PASSENGER LOADING ZONES – NO UNATTENDED VEHICLE.

A person commits an offense if the person parks, stops, or stands any vehicle and leaves it unattended in any passenger loading or no unattended vehicle zone.

SEC. 2-19. IMPEDING FLOW OF TRAFFIC.

A person commits an offense if he parks, stops or stands a vehicle in any Airport roadway, crosswalk, sidewalk, driveway, AOA, taxiway, parking area, passenger loading zone, material loading zone, at the taxi queue, or in front of or near any

entrance or exit to any building at the Airport so as to block, obstruct or impede the free passage of any vehicles or pedestrians.

SEC. 2-20. MATERIAL LOADING ZONES.

A person commits an offense if he:

- (1) stops, stands or parks any vehicle in a loading zone other than for unloading and delivery, pickup and loading of material by a vehicle authorized by the Airport Board for such use; or,
- (2) stops, stands or parks any delivery vehicle authorized by the Airport Board in a loading zone and exceeds the time limit or specified time window established by the Airport Board and posted in such loading zone.

SEC. 2-21. FAILURE TO PAY PARKING AND ACCESS CHARGES

A person commits an offense by failing to pay accrued parking or access charges at the Airport exits. This offense includes, but is not limited to, tow truck operators who remove vehicles from the Airport without paying the charges accrued by the vehicle being removed.

SEC. 2-22. PARKING DEFENSES.

- (a) Law Enforcement and Emergency Service Vehicles.

It is a defense to prosecution under this Chapter that a vehicle in violation was owned or operated by a law enforcement agency, fire department or Emergency Medical Service provider and parked to support the performance of official duties.

- (b) Authorized persons.

- (1) It is a defense to prosecution under this Chapter that a vehicle in violation:

- (A) was parked in a limited parking space and had parking authorization, in a form approved by the CEO and authorization was placed to be clearly visible on either the front windshield or rear window of the vehicle; or

- (B) stopped, stood, or parked at the direction of a law enforcement officer, a traffic or parking controller, or an official traffic control device.

**ARTICLE IV.
ADMINISTRATIVE ADJUDICATION OF PARKING VIOLATIONS.**

SEC. 2-23. PARKING VIOLATIONS MADE CIVIL OFFENSES.

Every violation of this chapter governing the stopping, standing, or parking of a vehicle is a civil offense.

SEC. 2-24. HEARING REQUIREMENT.

A person charged with a stopping, standing, or parking offense is entitled to a hearing within 15 calendar days of issuance of the citation.

SEC. 2-25. HEARING OFFICERS; POWERS, DUTIES, AND FUNCTIONS.

(a) Hearing officers shall be appointed by the Administrator to administratively adjudicate all parking violations for which a parking citation has been issued under this chapter of this Code.

(b) Hearing officers shall have the following powers, duties, and functions:

(1) to administer oaths;

(2) to accept admissions to, and to hear and determine contests of, parking violations under this section;

(3) to issue orders compelling the attendance of witnesses and the production of documents, which orders may be enforced by a municipal court;

(4) to assess civil fines, penalties, and other costs for a parking violation in accordance with this chapter;

(5) to waive penalties assessed for a parking violation in accordance with this chapter; and

(6) to preside over, hear evidence, and make findings at an immobilization or impoundment hearing in accordance with this chapter.

SEC. 2-26. PARKING CITATIONS; FORM.

(a) A parking citation serves as the summons and complaint for purposes of this chapter.

(b) A parking citation must be on a form prescribed by the Administrator, and must include the following information:

- (1) the nature, date, time, and location of the alleged parking violation;
- (2) the license plate number of the illegally parked vehicle, or if not visible or legible, the vehicle identification number or the inspection tag number;
- (3) the make of the illegally parked vehicle; and
- (4) all other information required by state law.

SEC. 2-27. SERVICE OF A PARKING CITATION; PRESUMPTION OF SERVICE.

- (a) A parking citation must be served personally upon the operator of a vehicle, if the operator is present at the time of service. If the operator is not present, or cannot otherwise be personally served, the parking citation must be affixed to the vehicle in a conspicuous place.
- (b) An operator of a vehicle who is not the vehicle's owner, but who uses or operates the vehicle with the express or implied permission of the owner, shall be considered the owner's agent authorized to receive a parking citation required to be served upon the registered owner or operator of a vehicle in accordance with the provisions of this section.
- (c) If the owner or operator of a vehicle drives the vehicle away from or in any manner leaves the site of the parking violation while the issuing officer is preparing the parking citation, or refuses service of the parking citation, this fact shall be noted on the original and all copies of the parking citation.
- (d) The original parking citation must be signed by the issuing officer who shall affirm the truth of the facts set forth in the citation. An electronic signature satisfies the signature requirement.
- (e) The original and all copies, including all electronic copies, of a parking citation are prima facie evidence that the parking citation was issued and that an attempt at service was made in accordance with the provisions of this section.

SEC. 2-28. LIABILITY OF THE VEHICLE OWNER AND OPERATOR; PRESUMPTION OF LIABILITY.

- (a) Except as provided in subsection (b), the registered owner and the operator of a vehicle, when not the same, shall both be liable to the Airport Board for a parking violation charge, except that the operator of a vehicle shall be solely liable if the owner can prove that the vehicle was operated without the owner's express or implied consent.

- (b) A vehicle owner who is engaged in the business of renting or leasing vehicles under written rental or leasing agreements shall not be liable for parking fines, penalties, and costs imposed by the Airport Board on a rented or leased vehicle if, within 30 days after receiving written notice of a parking violation, the vehicle owner provides in affidavit form the true name, address, driver's license number and state or country of issuance of the person in possession of the vehicle at the time the parking citation was issued, and a true copy of the lease or rental agreement in effect at the time the parking citation was issued. A lessor of a vehicle who fails to provide such information and documentation shall be treated as any other vehicle owner and shall be liable with the vehicle operator for a parking violation charge.
- (c) It is a defense to any charge of a parking violation that, at the time of the violation, the illegally parked vehicle was reported to a police department as having been stolen prior to the time of the violation and had not yet been recovered.

SEC. 2-29. ANSWERING A PARKING CITATION.

- (a) A person who has been issued a parking citation shall answer to the charge of the parking violation by the date shown on the citation. An answer may be made in any of the following ways:
 - (1) an admission of liability with payment of the applicable civil fine, and any additional penalties and costs;
 - (2) a denial of liability made before a hearing officer at an administrative adjudication hearing on a date specified in the parking citation or at an instanter hearing before that date;
 - (3) an admission of liability with an explanation made before a hearing officer at an administrative adjudication hearing on a date specified in the parking citation or at an instanter hearing before that date;
 - (4) a request for permission from a hearing officer to adjudicate by mail; or electronic mail;
 - (5) a request to reset a scheduled administrative adjudication hearing from the date shown on the parking citation. A scheduled hearing may not be reset more than once unless the person charged pays to the Administrator, or his designated representative, an amount equal to the applicable civil fine for the parking violation, with any additional penalties and costs.
- (b) The Administrator, or his designated representative, shall issue a receipt for any amounts paid under this section. After presentation of the receipt, all

amounts paid will be refunded to the person charged if the hearing officer, or a municipal court on appeal, finds that the person is not liable for the parking violation.

- (c) Payment of the civil fine and any additional penalties and costs may be made in person or by mailing to the Airport Board the parking citation accompanied by payment of the amount shown on the citation. Payment by mail may be made only by money order, check, or in a manner prescribed by the Administrator. Payment of the civil fine and all penalties and costs assessed pursuant to this section shall operate as a final disposition of the parking violation charge, except when payment is made to reset a scheduled hearing or to file an appeal.

SEC. 2-30. ADJUDICATION BY MAIL, ELECTRONIC MAIL, OR THROUGH THE ONLINE CITATION APPEAL SYSTEM.

- (a) If a person charged with a parking violation shows good cause for not attending a hearing, either personally or through a representative, the hearing officer may permit the matter to be adjudicated by mail, electronic mail, or through the online citation appeal system, which adjudication must be completed within 90 calendar days of the date of the citation.
- (b) Letters, memoranda, affidavits, photographs, and other documentary materials shall be admissible as evidence for the purposes of adjudication by mail, electronic mail or through the online citation appeal system. The hearing officer may exclude from consideration any material that is not relevant to the adjudication of the alleged violation.
- (c) Failure of the person charged to proceed with an adjudication by mail, electronic mail or through the online citation appeal system, after requesting and receiving permission to adjudicate by mail, electronic mail or through the online citation appeal system, is an admission by the person charged of liability for the parking violation and shall subject the person who requested the adjudication by mail, electronic mail or through the online citation appeal system, to the appropriate civil fines, penalties, and costs assessed by the hearing officer.
- (d) If a hearing officer determines that an adjudication cannot proceed by mail, electronic mail or through the online citation appeal system, the hearing officer shall advise the person charged by first class mail that the person must appear to answer the charge at a hearing.

SEC. 2-31. HEARINGS FOR DISPOSITION OF A PARKING CITATION; NOTICE OF DECISION.

- (a) Every hearing for the adjudication of a parking violation charge under this section shall be held before a hearing officer.
- (b) At a hearing, the parking citation is prima facie proof of its contents. The officer or other authorized person who issued the parking citation is not required to be present at a scheduled administrative hearing unless requested at least three days in advance of the hearing by the person charged or by the hearing officer.
- (c) At a hearing, the hearing officer shall hear and consider evidence presented by the Airport Board and by the person charged. The Texas rules of evidence do not apply to a hearing under this section, and the hearing officer shall make a decision based upon a preponderance of the evidence presented at the hearing, after giving due weight to all presumptions and prima facie evidence established by this section or other applicable law.
- (d) At the conclusion of an instant or a scheduled administrative adjudication hearing, the hearing officer shall immediately render an order or decision as to liability for the violation. The person charged shall also be notified of the right to appeal to municipal court, that failure to pay can result in immobilization and impoundment of the vehicle, and that the debt may be placed on the person's credit report for seven years or until the debt is paid.
- (e) If the person charged with a parking violation fails to answer the charge or to appear at a scheduled hearing, then within 7 calendar days after filing an order of liability issued under this section, a hearing officer shall notify the registered owner or operator of the vehicle in writing of the order. The notice must be sent by first class mail to the last address of the registered owner on record with the Texas Department of Transportation, or to the address of the registered owner or operator last known to the hearing officer.

SEC. 2-32. CIVIL FINE SCHEDULE.

- (a) All civil offenses under this chapter shall be punishable by a civil penalty of \$58.00, except for the following offenses:

<u>Violation</u>	<u>Civil Penalty</u>
Disabled Parking Space	\$ 500.00
Parking in a Fire Lane	\$ 68.00

- (b) Civil penalties for failure to pay parking fees shall be in addition to the parking fees themselves. When a vehicle is booted, a fee of \$100.00 shall also be assessed.
- (c) If a civil penalty is assessed, it must be in accordance with this section. A civil penalty may not be waived or modified by a hearing officer, or by a

municipal court on appeal, except that additional penalties and other costs may be added in accordance with this section.

(d) An additional penalty in an amount equal to the original civil penalty will be assessed if a vehicle owner or operator or the agent of the owner or operator fails to:

(1) answer to a parking violation charge within 15 calendar days after the date of issuance of the parking citation or fails to appear at any hearing scheduled after 15 calendar days from the date of the parking citation; or

(2) after being found liable, pay all civil fines, fees, and costs assessed for a parking violation within the time designated by the hearing officer.

(e) A penalty assessed under subsection (c) of this section may be waived by a hearing officer, or by a municipal court on appeal, if the vehicle owner or operator, or agent of the vehicle owner or operator, can establish that:

(1) through no fault of the vehicle owner or operator, or agent of the vehicle owner or operator:

(A) no notice of the parking violation was received as required by this chapter;

(B) no notice of the hearing officer's order was received as required by this chapter; or

(C) payment of the civil penalty assessed for the parking violation was not posted in a timely manner;

(2) the penalty was assessed in error; or

(3) the vehicle was at the time of the violation stopped, standing, or parked in response to a medical emergency.

SEC. 2-33. ENFORCEMENT OF ORDER.

In addition to the enforcement remedies allowed by state law, a hearing officer's order may be enforced by:

(a) impounding the vehicle that is the subject of the order when it is found within the boundaries of the Airport, if the person charged has committed three or more parking violations in any calendar year that have not been resolved either by a finding of no liability or by payment of all civil fines, penalties, and costs assessed by the hearing officer;

- (b) placing a boot on the vehicle that is the subject of the order when it is found within the boundaries of the Airport, if the person charged has committed three or more parking violations in any calendar year that have not been resolved either by a finding of no liability or by payment of all civil fines, penalties, and costs assessed by the hearing officer;
- (c) canceling or denying any permit to park or operate a transportation service at the Airport; and
- (d) reporting the debt to a credit reporting bureau, or any other civil remedy available at law.

SEC. 2-34. REMOVAL OF IMMOBILIZATION DEVICE.

- (a) The registered owner of an immobilized or impounded vehicle, or other authorized person, may secure the release of the vehicle upon:
 - (1) payment of the amount of the civil fine and late fees, if any, for each delinquent parking citation plus the applicable boot fees and towing and storage fees; or
 - (2) the posting of a cash bond in the amount of such civil fines, late fees, boot fees and towing and storage fees to ensure appearance at the immobilization/impoundment hearing.
- (b) Payment of the civil fines, late fees, boot fees, and any towing and storage fees shall constitute a waiver of the right to contest such civil fines and fees.
- (c) It shall be unlawful for any person, other than an officer or employee of the Airport Board acting in the course and scope of his duties under this section, to remove or attempt to remove or to tamper in any manner with an immobilization device (boot) installed on any vehicle pursuant to this section.
- (d) It shall be unlawful for any person, except under the direction of a peace officer, or an employee of the Airport Board, to tow, move, or to cause to be towed or moved any vehicle on which a boot is then installed pursuant to this section from the place where it was booted.
- (e) It shall be unlawful for any person, other than a peace officer or employee of the Airport Board acting in the course and scope of his duties, to remove or relocate any notice placed upon a booted vehicle under this section.
- (f) An offense under this section shall be a criminal offense punishable upon conviction by a criminal fine not to exceed Five Hundred Dollars (\$500).

SEC. 2-35. IMMOBILIZATION/IMPOUNDMENT HEARING.

- (a) The registered owner of a vehicle that is immobilized or impounded for the purpose of enforcing a hearing officer's order shall have the right to a prompt immobilization/impoundment hearing before a hearing officer.
- (b) The request for an immobilization/impoundment hearing must be made in writing to the Administrator, or his designated representative, on a form provided for that purpose, within 3 calendar days from the date the vehicle was immobilized or impounded, whichever occurred first.
- (c) An immobilization/impoundment hearing must be held within 48 hours after the Administrator, or his designated representative, receives the request for a hearing, excluding Saturdays, Sundays, and Airport Board holidays, at the parking adjudication office or at such other convenient and reasonable place as the hearing officer may designate.
- (d) The issue to be determined at the immobilization/impoundment hearing is whether the immobilization or impoundment of the vehicle was authorized by this chapter.
- (e) The immobilization or impoundment of a vehicle is valid if it complies with the requirements of this chapter, unless the vehicle owner or operator, or agent of the vehicle owner or operator, can establish that:
 - (1) the vehicle was registered to or operated by another person at the time the unresolved parking violations occurred;
 - (2) the vehicle was being operated without the owner's express or implied consent at the time the unresolved parking violations occurred; or
 - (3) through no fault of the owner, notice of the unresolved parking violations was never received as required by this section; and
 - (4) if the defective citations are dismissed, it would leave no more than two unresolved parking violations within the calendar year.
- (f) If the hearing officer determines that immobilization or impoundment of a vehicle was not valid, all fees paid for immobilization, towage, storage, and impoundment of the vehicle and any other amount paid to redeem the vehicle shall be refunded, including any civil fines, penalties, and costs for any parking violation that the hearing officer determines should not have been considered in counting parking violations for the purposes of immobilizing or impounding the vehicle. Any civil fines, penalties, and costs paid for a parking violation for which the registered owner was liable will not be refunded.

SEC. 2-36. APPEAL FROM HEARING.

- (a) A person determined by a hearing officer at a hearing, or by failure to answer a parking citation or appear at a hearing in the time required, to be in violation of a parking ordinance may appeal this determination to the municipal court in the manner and within the time allowed by state law.
- (b) The officer or other authorized person who issued the parking citation is not required to be present at the appeal hearing unless requested by the person charged or by the municipal court.
- (c) The appeal hearing must be a trial de novo in municipal court and is a civil proceeding for the purpose of affirming or reversing the hearing officer's order.
- (d) Service of notice of appeal under this section does not stay the enforcement and collection of any order of a hearing officer, unless the person filing the appeal pays to the Administrator an amount equal to all civil fines, penalties, and costs assessed against the person charged. The Administrator shall issue a receipt for any amounts paid under this subsection. After presentation of the receipt, all amounts paid will be refunded if the hearing officer's order is overturned on appeal.

SEC. 2-37. DISPOSITION OF CIVIL FINES, PENALTIES, AND COSTS.

All civil fines, penalties, and costs collected by the Airport Board under this chapter shall be paid into the Airport Board's general fund for the use and benefit of the Airport Board.

Chapter 8 Commercial Activities

ARTICLE I. GENERAL COMMERCIAL ACTIVITIES.

- Sec. 8-1. Commercial Activity.
- Sec. 8-2. Advertising.
- Sec. 8-3. Commercial Photography and Moving Picture Production.
- Sec. 8-4. News Racks.

ARTICLE II. FOOD ESTABLISHMENTS.

- Sec. 8-5. Designation of Health Authority.
- Sec. 8-6. State Regulations Adopted.
- Sec. 8-7. Definitions.
- Sec. 8-8. Food Permits.
- Sec. 8-9. Inspections.
- Sec. 8-10. Food Manager Certification.
- Sec. 8-11. Options.

ARTICLE III. POOLS AND SPAS.

- Sec. 8-12. Designation of Health Authority.
- Sec. 8-13. State Regulations Adopted.
- Sec. 8-14. Definitions.
- Sec. 8-15. Public Swimming Pool and Spa Permits.
- Sec. 8-16. Inspections.
- Sec. 8-17. Public Pool/Spa Manager Certification.

ARTICLE IV.
BUILDING SAFETY INSPECTION PROGRAM

Sec. 8-18. Certificate of Occupancy Holder Self-Inspection.

ARTICLE I.
GENERAL COMMERCIAL ACTIVITIES.

SEC. 8-1. COMMERCIAL ACTIVITY.

A person commits an offense if he conducts any commercial activity at the Airport without a permit, license, lease or other agreement with the Airport Board, except for the operation of aircraft. Commercial activity at the Airport includes the delivery of goods at the Airport for compensation (including rentals), the performance of services at the Airport for compensation, or the solicitation or facilitation of either type of business, regardless of how or where the solicitation or facilitation occurs. Commercial activity at the Airport specifically includes, but is not limited to, the transport of people or baggage from the Airport for compensation, and the transport of vehicles to or from the Airport for compensation. It also specifically includes the transport of people, baggage or vehicles to or from the Airport as a courtesy incidental to the parking business, the rental car business, or the hotel business.

SEC. 8-2. ADVERTISING.

A person commits an offense if he posts, distributes or displays any signs, advertisements, handbill, circular or printed or written matter of a commercial nature at the Airport or electronically advertises products or services available at the Airport without a concession or permit granted by the CEO.

SEC. 8-3. COMMERCIAL PHOTOGRAPHY AND MOVING PICTURE PRODUCTION.

- (a) A person commits an offense if he takes still or motion pictures for commercial use or public exhibition, publication, or display on any portion of the Airport grounds without a permit.
- (b) A person commits an offense if he produces any motion picture, television program or commercial advertisement on any portion of the Airport grounds without a permit.
- (c) No permits are needed for the taking of still or motion pictures or videotaping by:
 - (1) Airport users for personal non-commercial purposes; or

- (2) news media in covering news events or filming documentary productions at the Airport.
- (d) An application shall be submitted to the Airport Board at least five (5) business days in advance of the first day sought for photographic or other similar production, and shall include the following:
- (1) the full name and street address of the applicant;
 - (2) the full name and street address of the organization sponsoring, conducting, or promoting the production;
 - (3) whether the producing organization is a branch or division of a national organization and, if so, the name and street address thereof;
 - (4) if the producing organization is a Texas corporation, a copy of its certificate of incorporation, as amended, shall be furnished; if it is a foreign corporation, a copy of its certificate to do business in the State of Texas shall accompany the application;
 - (5) the purpose of the production;
 - (6) the date or dates and hours of the production;
 - (7) the location(s) proposed for such production; and
 - (8) the total number and size of production equipment required for the production and total number of personnel.
- (e) The permit will be issued within three (3) business days of receipt of the application; however, the permit application may be denied or a permit granted hereunder revoked if one or more of the statements in the application is found to be untrue.
- (f) Time, location and manner: When permits are granted, the following rules and standards will apply:
- (1) location: Permittees shall be escorted by Airport Board Personnel at all times and shall only be permitted to conduct the permitted activity in those locations specified in the permit.
 - (2) Permits will be issued for a period of not more than thirty (30) days.
 - (3) manner of operation:

- (A) a person may not engage in such production unless he carries such permit granted under this section at all times while conducting production activities.
- (B) a person conducting production activities hereunder shall, in that connection, obey all applicable state and federal laws and all applicable rules and regulations of the Airport Board. Unless specified in the permit, permittees will not be permitted to conduct the activity for which the permit is issued:
 - (i) in Airport roadways,
 - (ii) inside airline gate departure lounges,
 - (iii) in areas restricted to airline or Airport personnel,
 - (iv) in restrooms,
 - (v) in premises leased to a concessionaire,
 - (vi) in stairwells, staircases, elevators or escalators,
 - (vii) in baggage claim areas, or
 - (viii) in any area temporarily or permanently restricted for conducting or promoting the production.

SEC. 8-4. NEWSRACKS.

A person commits an offense if he sells or distributes any publication on the Airport premises by means of newspaper stand, racks or other similar devices, except by franchise, concession or permit granted by the Airport Board.

**ARTICLE II.
FOOD ESTABLISHMENTS.**

SEC. 8-5. DESIGNATION OF HEALTH AUTHORITY.

The Airport Board shall by resolution designate from time to time a health authority for the purpose of ensuring minimum standards of environmental health and sanitation within the scope of that department's function.

SEC. 8-6. STATE REGULATIONS ADOPTED.

- (a) The following statutory provisions are hereby adopted by reference: Texas Board of Health's "Texas Food Establishment Rules" 25 TAC sections 229.161-229.171, 229.173-229.175; Health and Safety Code, Chapter 431-"Texas Food, Drug and Cosmetic Act"; and Health and Safety Code Chapter 341-"Minimum Standards of Sanitation and Health Protection."
- (b) A certified copy of each rule manual (above) shall be kept on file in the office of the Airport Concessions Department.

SEC. 8-7. DEFINITIONS.

All definitions in the "Texas Food Establishment Rules" are hereby incorporated by reference. In addition, the following definitions shall be understood.

HEALTH AUTHORITY shall be understood to mean the representatives of any health department or health agency designated by the Airport Board to enforce the provisions herein by resolution of the Airport Board.

SERVICE OF NOTICE shall mean a notice provided for in these rules is properly served when it is delivered to the holder of the permit or the person in charge, or when it is sent by registered or certified mail, return receipt requested, to the last known address of the holder of the permit.

FOOD ESTABLISHMENT shall mean all places where food or drink are stored, sold, commercially prepared, or otherwise handled, whether offered for sale, given in exchange, or given away for use as food or furnished for human consumption. The location of commercially packaged single portion non-potentially hazardous snack items and wrapped candy sold over the counter, or by vending machine, is excluded.

SEC. 8-8. FOOD PERMITS.

- (a) Requirement: A person commits an offense if he operates a food establishment at the Airport without possessing a current and valid health permit issued by the health authority designated by resolution of the Airport Board.
- (b) Posting: A valid permit shall be posted in public view in a conspicuous place at the food establishment for which it is issued.
- (c) Non-transference (Change of ownership): Permits issued under the provisions of this article are not transferable. Upon change of ownership of a business the new business owner will be required to meet current standards as defined herein and Texas law before a permit will be issued.

- (d) Multiple permits: A separate permit shall be required for every type food establishment and temporary food establishment whether situated in the same building or at a separate location, except that:
- (1) lounge operations located in the same building operating under the same liquor license will not require a separate permit unless potentially hazardous food is being served; and
 - (2) establishments with minimal food handling involving limited preparation of potentially hazardous food (such as a snack bar) and under common ownership may be grouped under one permit. All establishments with extensive food handling or open potentially hazardous foods will be required to have a separate permit.
- (e) Suspension of permit: The health authority may suspend any permit to operate a food establishment if the operation of the establishment does not comply with the requirements of this chapter, Texas laws, or the operation of the food establishment otherwise constitutes an imminent health hazard. Before a permit is suspended, the holder of the permit, or the person in charge, shall be notified in writing that their permit may be suspended and that they are entitled to a hearing, if a request for hearing is made in writing to the authority within ten (10) days from the date the notice of suspension is received. If no written request for hearing is filed within ten (10) days, the permit will be suspended. The health authority may end the suspension any time if reasons for suspension no longer exist. When a permit is suspended, food service operations shall immediately cease.
- (f) Revocation of permit: The health authority may, after providing notice and an opportunity for a hearing, revoke a permit for serious or repeated violations of any of the requirements of these rules or for interference with the health authority in the performance of its duties. Prior to revocation, the health authority shall notify the holder of the permit, or the person in charge, in writing of the reason for which the permit is subject to revocation and that the permit shall be revoked at the end of ten (10) days following service of such notice unless a written request for a hearing is filed with the health authority by the holder of the permit within the ten (10) day period. If no written request for hearing is filed within the ten (10) days, revocation will be final.
- (g) Service of notices: Notices shall be served in accordance with the definition of "service of notice", above. A copy of the notice shall be filed in the records of the health authority and in the office of the Vice President of Airport Concessions, or to such other person as may be designated by the Airport Board.
- (h) Hearings: The hearings provided for in these rules shall be conducted by the health authority at a time and place designated by it. Based upon the

recorded evidence of such hearings, the health authority shall make a final finding, and shall sustain, modify or rescind any notice or order considered in the hearing. A written report of the hearing decision shall be furnished to the office of the Airport Concessions Department and the holder of the permit, license, or certificate.

- (i) Right of appeal: Any permit holder who wishes to dispute the decision of a hearing may appeal the decision to the director of the health authority issuing the order being appealed.
- (j) Application after revocation: When a revocation of a permit has become final, the holder of the revoked permit may make written application to the health authority for a new permit.
- (k) Permit fees: Health permit fees, as established by the health authority, are due and payable directly to the health authority in the amounts and at the times specified by the health authority.

SEC. 8-9. INSPECTIONS.

- (a) Pre-operational inspection: The health authority shall inspect any food establishment prior to its beginning operation to determine compliance with this chapter.
- (b) On-going operations: The health authority shall be entitled to inspect any food establishment at any time without prior notice in order to determine compliance with this chapter.

SEC. 8-10. FOOD MANAGER CERTIFICATION.

- (a) Requirements: A person commits an offense if he operates a food establishment at the Airport without a manager, or person in charge, who possesses a valid and current food manager's certificate, or equivalent, approved by the health authority designated by resolution of the Airport Board. A certified manager, or person in charge, must be on duty during all hours of operation of any nonexempt food service establishment employing six (6) or more employees; provided that, only one certified manager, or person in charge, shall be required to be on duty during all hours of operation in each terminal building for food establishments under common ownership and operation. Only one certified manager, or person in charge, shall be required to be on duty during all hours of operation at each hotel.
- (b) Manager's certification: Upon written application and presentation of evidence of satisfactory completion of a food manager's course, equivalent training or examination as approved by the health authority, the health authority shall issue a food manager's certificate valid for three (3) years from the date of

training or evaluation unless sooner revoked. Suspension or revocation of an establishment's health permit by the health authority shall constitute cause for revocation of that manager's certification. Whenever the food service operator holding the manager's certificate terminates employment, is terminated, or is transferred to another food establishment, the person owning, operating or managing the food establishment shall be allowed sixty (60) days from the date of termination or transfer of the certificate holder to comply with this section.

- (c) Exemptions from certificate requirement: Temporary food establishments and persons participating as volunteer food handlers performing charitable activities for periods of fourteen (14) days or less may be exempted from the requirement for manager's certificate. Exemptions are within the discretion of the health authority.

SEC. 8-11. OPTIONS.

Notwithstanding the provisions of this chapter which provide for grouping of food establishments under one permit, and one certified manager for food establishments under common ownership and operation, each business owner shall have the option to waive the grouping provisions and obtain one permit for each food establishment or temporary food establishment, and to maintain one certified manager, or person in charge, for each food establishment location.

ARTICLE III. POOLS AND SPAS.

SEC. 8-12. DESIGNATION OF HEALTH AUTHORITY.

The Airport Board shall by resolution designate from time to time a health authority for the purpose of ensuring minimum standards of environmental health and sanitation within the scope of that department's function.

SEC. 8-13. STATE REGULATIONS ADOPTED.

- (a) The following statutory provisions are hereby adopted by reference: Texas Department of Health Minimum Standards of Sanitation and Health Protection Measures, Chapter 341, Subchapter D, Section 341.064 and Design Standards for Public Swimming Pool Construction, 25 TAC, Chapter 337, Section 337.71 through 337.96.
- (b) A certified copy of each rule manual (above) shall be kept on file in the office of the Commercial Development Department.

SEC. 8-14. DEFINITIONS.

All definitions in the Texas Minimum Standards and Health Protection Measures and Design Standards for Public Swimming Pool Construction are hereby incorporated by reference. In addition, the following definitions shall be understood.

HEALTH AUTHORITY shall be understood to mean the representatives of any health department or health agency designated by the Airport Board to enforce the provisions herein by resolution of the Airport Board.

SERVICE OF NOTICE provided for in these rules is properly served when it is delivered to the holder of the permit or the person in charge, or when it is sent by registered or certified mail, return receipt requested, to the last known address of the holder of the permit.

PUBLIC SWIMMING POOL shall mean an artificial body of water, including a spa, maintained expressly for public recreational purposes, swimming and similar aquatic sports or therapeutic purposes.

SEC. 8-15. PUBLIC SWIMMING POOL AND SPA PERMITS.

- (a) Requirement: A person commits an offense if he operates a public swimming pool or public spa at the Airport without possessing a current and valid health permit issued by the health authority designated by resolution of the Airport Board.
- (b) Posting: A valid permit shall be posted in public view in a conspicuous place at the public swimming pool and public spa.
- (c) Non-transference (Change of ownership): Permits issued under the provisions of this article are not transferable. Upon change of ownership of a business the new business owner will be required to meet current standards as defined herein and State law before a permit will be issued.
- (d) Separate permits: A separate permit shall be required for every public swimming pool and public spa, whether situated in the same building or at a separate location.
- (e) Suspension of permit: The health authority may suspend any permit to operate a public swimming pool or public spa if the operation of the establishment does not comply with the requirements of this chapter, Texas laws or the operation of the establishment otherwise constitutes an imminent health hazard. Before a permit is suspended, the holder of the permit or the person in charge, shall be notified in writing that their permit may be suspended and that they are entitled to a hearing if a request for hearing is made in writing to the authority within ten (10) days from the date the notice of suspension is received. If no written request for hearing is filed within ten (10)

days, the permit will be suspended. The health authority may end the suspension any time if reasons for suspension no longer exist. When a permit is suspended, use of the public swimming pool or public spa shall immediately cease.

- (f) Revocation of permit: The health authority may, after providing notice and an opportunity for a hearing, revoke a permit for serious or repeated violations of any of the requirements of these rules or for interference with the health authority in the performance of its duties. Prior to revocation, the health authority shall notify the holder of the permit, or the person in charge, in writing of the reason for which the permit is subject to revocation and that the permit shall be revoked at the end of ten (10) days following service of such notice unless a written request for a hearing is filed with the health authority by the holder of the permit within the ten (10) day period. If no written request for hearing is filed within the ten (10) days, revocation will be final.
- (g) Service of Notices: Notices shall be served in accordance with the definition of "service of notice" above. A copy of the notice shall be filed in the records of the health authority and in the office of the Vice President of Commercial Development, or to such other person as may be designated by the Airport Board.
- (h) Hearings: The hearings provided for in these rules shall be conducted by the health authority at a time and place designated by it. Based upon the recorded evidence of such hearings, the health authority shall make a final finding, and shall sustain, modify or rescind any notice or order considered in the hearing. A written report of the hearing decision shall be furnished to the office of the Vice President of Commercial Development and the holder of the permit, license, or certificate.
- (i) Right of appeal: Any permit holder who wishes to dispute the decision of a hearing may appeal the decision to the director of the health authority issuing the order being appealed.
- (j) Application after revocation: When a revocation of a permit has become final, the holder of the revoked permit may make written application to the health authority for a new permit.
- (k) Permit fees: Health permit fees, as established by the health authority, are due and payable directly to the health authority in the amounts and at the times specified by the health authority.

SEC. 8-16. INSPECTIONS.

- (a) Pre-operational inspection: The health authority shall inspect any public swimming pool and public spa prior to its beginning operation to determine compliance with these rules.
- (b) On-going operations: The health authority shall be entitled to inspect any public swimming pool and public spa at any time without prior notice in order to determine compliance with these rules.

SEC. 8-17. PUBLIC POOL/SPA MANAGER CERTIFICATION.

- (a) Requirement: A person commits an offense if he operates a public swimming pool or spa at the Airport without a manager or person in charge, who possesses a valid and current pool/spa manager's certificate or equivalent, approved by the health authority designated by resolution of the Airport Board. Pool or spa managers shall have at least one certified pool manager employed to maintain the pools/spas per location.
- (b) Manager's certification: Upon written application and presentation of evidence of satisfactory completion of a pool/spa manager's course, equivalent training or examination as approved by the health authority, the health authority shall issue a pool/spa manager's certificate valid for one (1) year from the date of training or evaluation unless sooner revoked. Suspension or revocation of an establishment's health permit by the health authority shall constitute cause for revocation of that manager's certification. Whenever the public pool/spa manager holding the certificate terminates employment or is terminated or transferred, the business shall be allowed sixty (60) days from this termination or transfer date to provide a new certificate holder.
- (c) This requirement is applicable even if pool maintenance operations are contracted to an outside company.

ARTICLE IV.
BUILDING SAFETY INSPECTION PROGRAM.

SEC. 8-18. CERTIFICATE OF OCCUPANCY HOLDER SELF-INSPECTION.

The holder of a certificate of occupancy for any building at DFW International Airport shall be required to comply with the requirements of the Airport's Building Safety Inspection Program, as approved by the Airport Board. Certificate holders shall be required to hire professional engineers to inspect properties that are at least 30 years old for code compliance and life safety, and to submit a written report to DFW Airport code enforcement officials, detailing and certifying their findings. After the first of such inspections, certificate holders are required to obtain and submit reinspection reports every 10 years. Nothing in this inspection program shall restrict the authority of DFW

Airport to perform its own inspections to determine whether repairs or other modifications are necessary. Nothing in this inspection program shall restrict the certificate holder's right to rely on grandfather privileges under applicable codes, provided that no such grandfather privileges shall justify conditions that make any building unsafe for occupancy. The inspection reports shall be submitted within six months of the date this Code section is enacted, or the date the building reaches 30 years of age, whichever occurs later. Reinspection reports shall be submitted within six months of the 10th anniversary of the prior report. Failure to comply with the requirements of this section shall be an offense under this Code, in addition to administrative penalties such as revocation of certificates of occupancy.